

Original Operating Instructions

Mechanical Ventilation Heat Recovery Unit FOCUS (F) 200



*FOCUS 200

Preamble

*Thank you for deciding on the **heat recovery unit FOCUS (F) 200***

Legal provisions

All rights reserved.

This operating manual has been compiled with the greatest care. However, the editor does not assume any liability for damages resulting from missing or incorrect information contained in this operating manual. We reserve the right to change the content of this manual partially or completely at any time without prior notification.

The information contained in these documents is the property of PAUL Wärmerückgewinnung GmbH. The publication, whether partially or completely, requires the written consent of PAUL Wärmerückgewinnung GmbH. Any in-house reproduction intended to evaluate the product or for proper use is permitted and is not subject to approval.

Trademarks

All trademarks are acknowledged, even if they are not labelled separately. A missing labelling does not mean that a good or sign is free of trademark rights.

© 2014 PAUL Wärmerückgewinnung GmbH. All rights reserved.

Validity

This document applies to the following types of devices:

- FOCUS (F) 200 series

The types of device FOCUS (F) 200, are hereinafter referred to under the product name FOCUS, unless details are for type differentiation.

The heat recovery unit (HRU) FOCUS has been built according to the current state of the art and the acknowledged rules on safety. The device is subject to permanent improvement and development. Therefore, your device may differ slightly from the instructions.

In order to guarantee a safe, appropriate and economic operation of the heat recovery unit FOCUS, please observe and comply with all information and notes on safety in this operating manual.

Subject of this operating manual is the heat recovery unit FOCUS in different design variants. Possible accessories are only described insofar as it is necessary for the appropriate operation. Please see the particular manuals for further information on accessories.

Target group

The operating manual is intended for operators and qualified personnel. The activities may only be carried out by personnel having a corresponding formation and being sufficiently qualified for the respective work.

Besides the general section 1 Introduction, this manual consists of:

- A part for the operator and qualified personnel → section 1 and 2
- A part specifically intended for qualified personnel → section 1 and 3

Index

1	Introduction	6
1.1	Warranty and Liability	6
1.1.1	Warrant Terms	6
1.1.2	Liability	6
1.2	Safety	6
1.2.1	Intended use	6
1.2.1.1	Heat recovery unit FOCUS	6
1.2.1.2	Control unit.....	7
1.2.2	Qualification of the target group.....	7
1.2.2.1	Operators	7
1.2.2.2	Qualified personnel	7
1.3	Notes on safety	7
1.3.1	Safety appliances and measures.....	7
1.3.2	Used symbols.....	7
2	Hints for the operator and the qualified personnel	8
2.1	Product description	8
2.1.1	Type plate	9
2.1.2	Requirements on the assembly site.....	9
2.1.3	Frost protection	9
2.1.4	Joint operation with heat-producing appliances.....	9
2.2	Available control modules	9
2.2.1	LED control panel	10
2.2.1.1	Operating functions LED control panel.....	10
2.2.1.2	Signalling of operating and error conditions	12
2.2.2	TFT touch panel	13
2.2.2.1	Operating function and signalling of the TFT touch panel	13
2.3	Menu structure of the TFT touch panel.....	16
2.3.1	Main menu Information	17
2.3.1.1	Submenu Current message	17
2.3.1.2	Submenu Last messages	17
2.3.1.3	Submenu Fan speeds.....	17
2.3.1.4	Submenu Current status of the device	17
2.3.1.5	Submenu Software versions	17
2.3.1.6	Submenu Connected devices	17
2.3.1.7	Submenu Filter run-time	17
2.3.1.8	Submenu Operating hours	17
2.3.2	Main menu Settings	17
2.3.2.1	Submenu Fan speeds.....	17
2.3.2.2	Submenu Filter.....	18
2.3.2.3	Submenu Frost protection.....	18
2.3.2.4	Submenu Automatic.....	19
2.3.2.4.1	Automatic timing.....	19
2.3.2.4.2	Automatic sensor	20
2.3.2.5	Submenu Date/Time	21
2.3.2.6	Submenu Choose language	21
2.3.2.7	Submenu Screen dimming.....	21
2.3.2.8	Submenu Key lock	22
2.3.2.9	Submenu Summer ventilation without by-pass.....	22
2.3.2.10	Submenu Supply heater	22
2.3.2.11	Submenu Ground pipe diverter.....	22
2.3.2.12	Submenu brine loop cooling	23
2.3.3	Boost ventilation mode with external boost ventilation sensing device	23
2.4	Maintenance by the operator	23
2.4.1	Replacement of the filter	23
2.4.2	Resetting the filter run-time.....	26

2.4.2.1	Resetting the filter run-time by means of the LED control panel	26
2.4.2.2	Resetting the filter run-time by means of the TFT touch panel.....	27
2.4.3	What to Do in the Event of a Failure?	27
2.5	Disposal.....	27
3	Hints for qualified personnel	28
3.1	Prinzipal configuration of the system	28
3.2	Installation requirements	28
3.2.1	Transport and packing	29
3.2.2	Checking of the scope of delivery	29
3.3	Mounting.....	29
3.3.1	Wall mounting	29
3.3.2	Mounting on a mounting frame	31
3.3.3	Air duct connection.....	33
3.3.4	Connection of the Condensate Drain.....	33
3.4	Electrical connections	35
3.4.1	Connection of the adapter board	35
3.4.2	Connection of the TFT touch panel.....	36
3.4.3	Connection of several TFT touch panels	37
3.4.4	Connection of the LED control panel	38
3.4.5	Connection of external boost ventilation switch.....	38
3.4.6	Connection of external sensors	38
3.4.7	Connection status relay.....	39
3.4.8	Connection external release	39
3.4.9	Connection digital inputs or outputs.....	39
3.4.10	Operation without a control unit connected.....	40
3.5	Commissioning of the FOCUS	40
3.5.1	Operational readiness	40
3.5.2	Adjusting the air volume flow	40
3.5.2.1	Adjustment of the nominal air flow with TFT touch panel	40
3.5.2.2	Adjustment of the nominal air flow with LED control panel.....	41
3.5.3	Adjustment of the Valves	42
3.6	Menu settings by qualified personnel / service staff	42
3.6.1	Main menu Setup	42
3.6.1.1	Submenu Frost protection.....	42
3.6.1.2	Submenu Fan speeds	43
3.6.1.3	Submenu Post-heating.....	44
3.6.1.4	Submenu Summer ventilation without by-pass	44
3.6.1.5	Submenu Ground pipe diverter valve	45
3.6.1.6	Submenu Reset factory data.....	45
3.7	Maintenance and repair by qualified personnel	46
3.7.1	Inspecting and cleaning the heat exchanger	46
3.7.2	Replacement of the heat exchanger type	49
3.8	Visualisation of errors and error treatment.....	50
3.8.1	Error signalling by means of the LED control panel.....	50
3.8.2	Visualisation of errors with the TFT touch panel.....	50
3.9	Technical description	52
3.9.1	Types of device	52
3.9.2	Designs layout air connection	52
3.9.3	Technical specification	52
3.9.4	Dimensional sketch	54
3.9.5	Plant 1 circuit diagram FOCUS (F) 200	55
3.9.6	Plant 2 terminal scheme master controller.....	56

Appendix:

Check List A Maintenance Works of the User
Check List B Maintenance Works of skilled Personnel
Air Flow Report
Commissioning and Handover Certificate
EC Declaration of Conformity FOCUS (F) 200 series

1 Introduction

This section contains general information on the heat recovery unit FOCUS.

1.1 Warranty and Liability

1.1.1 Warrant Terms

Our "General Terms and Conditions" apply to the FOCUS in their respectively valid version. The warranty is determined by the legal warranty terms. It solely applies to the replacement of material and does not include the service. It only applies if it is proven that maintenance is carried out by qualified personnel in accordance with our regulations.

The warranty shall expire once/ when:

- the warranty period has elapsed;
- the device is operated without original Paul-filters;
- parts are installed which were not delivered by the manufacturer;
- the device is improperly used;
- the defects occur due to incorrect connection, improper use or soiling of the system;
- unauthorised changes or modifications on the plant are made.

1.1.2 Liability

The FOCUS was developed and manufactured for use in so-called comfort ventilation systems. Any other use is considered as "improper use" and can result in damages to the focus or in personal injuries, for which the manufacturer cannot be made liable. The manufacturer is not liable for any damage, which is due to the following causes:

- Non-observance of the notes on safety, operation and maintenance, stated in this manual;
- The installation was not performed according to the regulations;
- Mounting of the spare parts, which were not delivered and prescribed by the manufacturer;
- The defects occur due to incorrect connection, improper use or soiling of the system;
- The warranty period has elapsed;
- Normal wear.

1.2 Safety

Please always observe the safety instructions in this operating manual. The non-observance of the safety instructions, warning notices, notes and instructions can lead to injuries or damages to the FOCUS.

1.2.1 Intended use

This device is not intended to be used, maintained or cleaned by persons (including children) with limited physical, sensory or mental aptitude or without sufficient experience and/or knowledge, unless they are supervised by a person responsible for safety or have received instructions by that person on how to use, maintain and clean the device. Children must not play with the device.

1.2.1.1 Heat recovery unit FOCUS

The heat recovery unit can be used for controlled ventilation in living and office areas (with reservations in the industrial sector) at usual interior air humidity of approx. 40 – 70 % r. F., temporarily up to approx. 80 % r. F. Any other use is considered as being diverted from the intended use. The heat recovery unit is not designed to discharge excessive air humidity, especially in the first utilisation phase of new buildings.

For safety reasons, it is not permitted to modify the product or to install parts which are not expressly recommended for this product or distributed by PAUL Wärmerückgewinnung GmbH. Only use the FOCUS in accordance with the information contained in the enclosed documentation and the standards and directives valid on site:

- Do not mount the device in explosion-prone areas;
- Do not use the device to exhaust inflammable or explosive gases;

Lethal voltages occur inside the FOCUS:

- Only operate the device with the casing cover being mounted;

The specifications mentioned in this document must not be changed:

- The instructions for regular checking and maintenance of the device must be strictly complied with;
 - Any modification of the FOCUS is prohibited;
- All enclosed documentation is a part of the product:
- Read and observe the documentation;
 - Store the documentation in such a way that they are accessible at any time.

1.2.1.2 Control unit

By means of the control units TFT touch panel or LED control panel, you configure and operate the system from a central point. Both control units are exclusively suitable for indoor use.

1.2.2 Qualification of the target group

1.2.2.1 Operators

Operators must be instructed by qualified personnel:

- Instruction on risks when handling electrical devices;
- Instruction on the operation of the system;
- Instruction on the maintenance of the FOCUS;
- Knowledge and observance of this manual with all notes on safety.

1.2.2.2 Qualified personnel

Qualified personnel must possess the following qualifications:

- Training in dealing with dangers and risks by the installation and operation of electric devices;
- Training for the installation and commissioning of electrical equipment;
- Knowledge and attention of the building, security and installation rules valid on the spot of the appropriate municipalities, the waterworks and power plant and other official rules and directives;
- Knowledge and observance of this document with all safety notices.

Only a recognized specialist is, unless otherwise specified in this manual, entitled the FOCUS to install, connect, bring into service and maintain.

1.3 Notes on safety

1.3.1 Safety appliances and measures

- Do not operate the FOCUS without having connected air ducts with a minimum length of 900 mm;
- The casing of the FOCUS cannot be opened without tools;
- Before opening the casing, the device must be disconnected from the power supply;
- When working on electronic parts of the device, an antistatic wrist strap must be worn.
- Replacement of spare parts and accessories only with the original of the manufacturer allowed

1.3.2 Used symbols

This manual contains the following advisory and safety symbols:



Special notice!



Caution, risk of:

- Damages to the device or the system

- Impairment of the device's operation, if the instructions are not strictly complied with.



Caution, risk of:

- Injury of the operator or the qualified personnel

2 Hints for the operator and the qualified personnel

This section describes how to use the FOCUS.

2.1 Product description

The FOCUS is a ventilation device with heat recovery for healthy, balanced and energy-saving comfort ventilation. A comfort ventilation system consists in exhausting stale, odorous air for example from the kitchen, the bathroom, W.C.s and in introducing an equal quantity of fresh air into living rooms, bedrooms and children's rooms.

In the FOCUS 200 series are designed with patented reverse flow channel heat exchanger of plastic for the heat recovery. The FOCUS F 200 series are equipped with a membrane moisture heat exchanger (enthalpy exchanger) which, due to its physical properties, is not only able to transfer heat, but also moisture. The casing is made of powder-coated sheet metal with anthracite colouring. The internal lining made of high-quality polypropylene provides the necessary heat insulation and device noise protection.

The FOCUS includes two maintenance-free 230 Vac radial fans with the integrated power supply unit and electronic commutation. The volume flow constant fans keep the air quantity at a constant speed for each selected fan rotary speed. The air quantity is also not affected by soiled filters.

One filter each for the intake air and the extract are installed in the device. They consist of a synthetic woven filter medium with a frame made of polypropylene. Access to the filtering is done on the front plate.

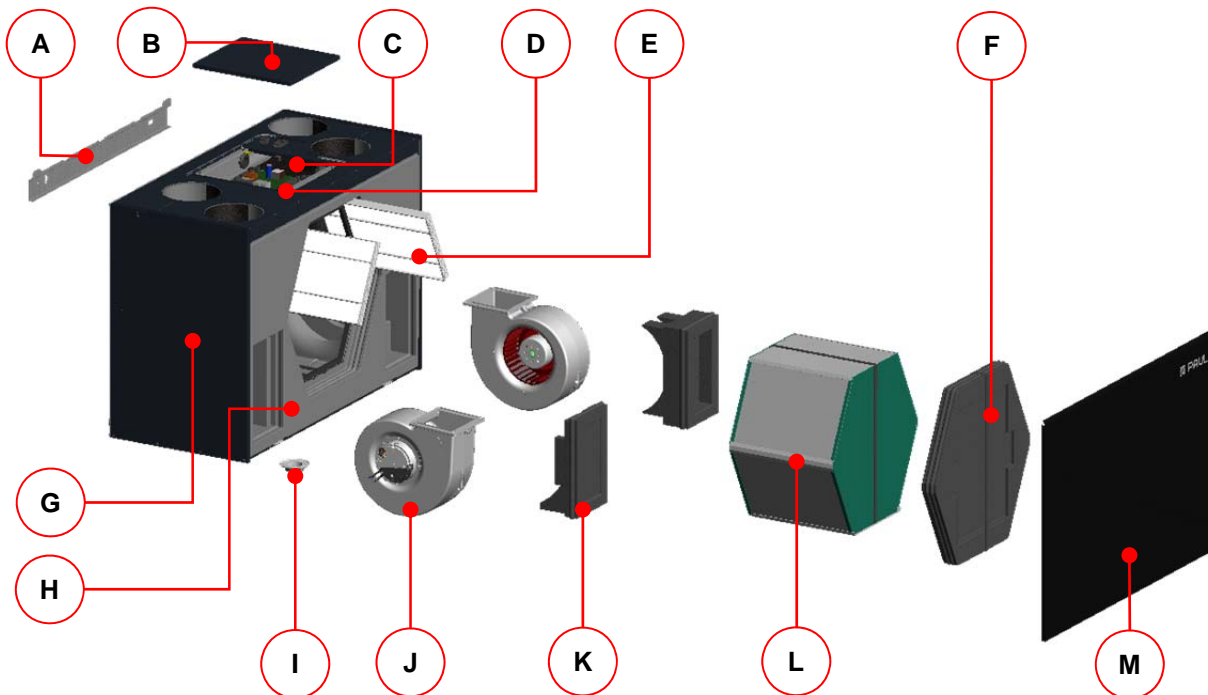

Fig 1: Main components FOCUS

Item	Designation
A	Mounting sheet
B	Cover sheet control
C	3-pole IEC connector and RJ45 jack
D	Control boards
E	Filter (2x)
F	EPP foam cover for filter and heat exchanger with strap
G	Housing made of coated steel sheet

H	EPP moulded parts
I	Screw connection condensate connection
J	Fans (2x)
K	EPP foam cover for fan (2x)
L	Heat exchanger with condensate pan
M	Front plate of coated steel sheet

Tab. 1: Main components FOCUS

2.1.1 Type plate

The type plate clearly identifies the product. The information on the type plate is necessary for the safe use of the product and in case of service-related questions. The type plate is located on the side of the air connections of the HRU. The type plate must be permanently attached to the product.

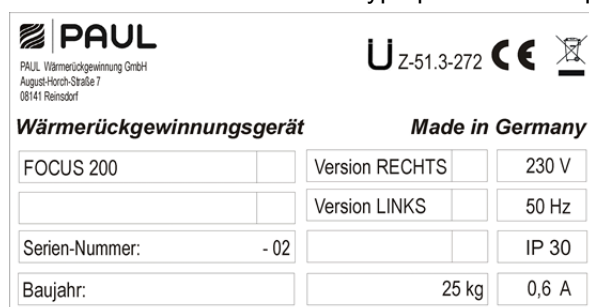

Fig 2: Type plate FOCUS 200

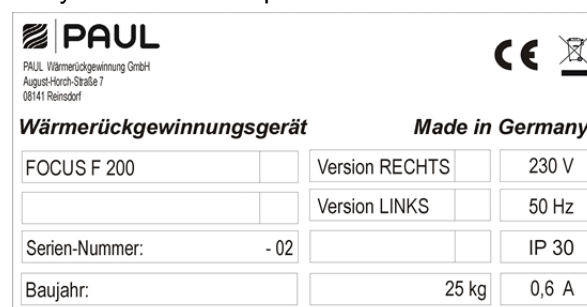

Fig 3: Type plate FOCUS F 200

2.1.2 Requirements on the assembly site

The heat recovery unit is suitable for being mounted in frost-free interior areas. The indoor-climate ambient conditions must not permanently exceed 70 % r. F. at 22 °C.

2.1.3 Frost protection

The FOCUS is equipped with automatic frost protection which prevents that the heat exchanger freezes at very low outside air temperatures. Depending on the set frost protection mode, the fans are temporarily switched off when falling below the threshold values of the device intake air limit temperature.

The automatic frost protection for monitoring the supply air temperature serves as freezing protection of an optional downstream hydraulic heater battery and temporarily switches off the fans when falling below the threshold values of the limit temperature for the supply air.

2.1.4 Joint operation with heat-producing appliances

In case of simultaneous operation with heat-producing appliances, e.g. chimneys, the corresponding standards and regulations must be complied with by the qualified personnel. The joint operation of indoor air-dependant heat-producing appliances and ventilation plants requires an appropriate safety device (differential pressure switch) or a plant-specific measure, in the event that dangerous negative pressures can be generated in the installation room of the heat-producing appliance during operation. The FOCUS is set up for the joint operation with heat-producing appliances.

2.2 Available control modules

The FOCUS can be equipped with the following control panels:

- Control unit LED control panel (w x h x d in mm: 80 x 80 x 12)
- Control unit TFT touch panel (w x h x d in mm: 102 x 78 x 14)
- External boost ventilation switch (any number, potential-free)
- External sensors with sensor signal 0-10 V or 4-20 mA

These control modules are explained in more detail in the following sections.

2.2.1 LED control panel

The LED control panel has 7 symbolized short-stroke keys. By pressing a key or key combination, the corresponding operations are performed. The active mode of operation is signaled by means green or red LED. For the LED control panel in the design of the PEHA switch range, both on-wall and in-wall installation is possible. In the case of surface mounting a PEHA surface box is required.

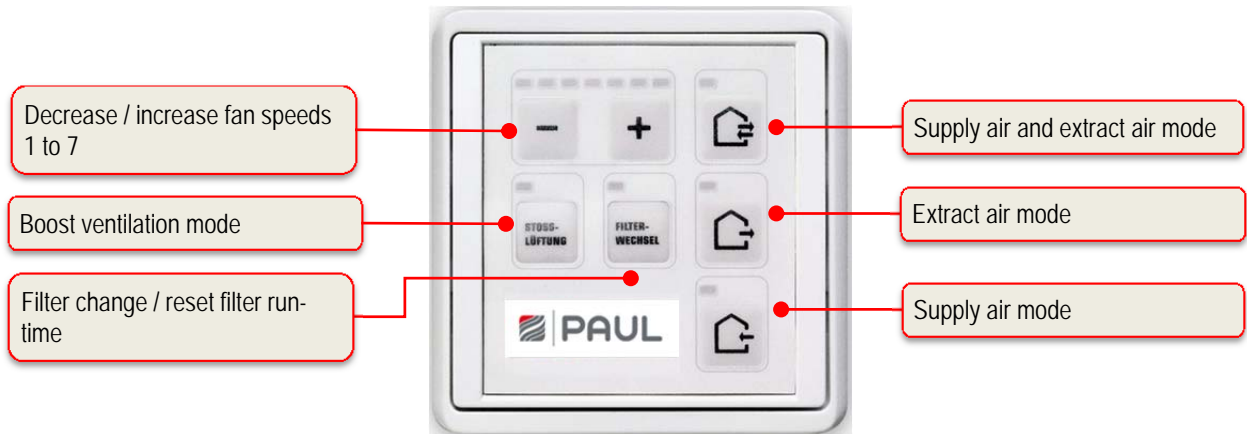











Fig 4: Control and information fields of the LED control panel

2.2.1.1 Operating functions LED control panel

Symbol	Designation	Explanation
	Key Supply air and extract air mode	By pressing this key, the supply and extract air mode are set.
	Key Extract air mode	By pressing this key, only the extract air mode is set. The supply air mode is switched off. <i>If the ventilation device is operated with a heat-producing appliance, this key must be permanently deactivated! The simultaneous operation of ventilation plant and heat-producing appliance requires increased safety-related requirements for negative pressure monitoring with a switch-off function for the ventilation device.</i>
	Key Supply air mode	By pressing this key, only the supply air mode is set. The extract air mode is switched off.
	Key Decrease fan speed	By pressing this key, the fan speed is gradually decreased.
	Key Increase fan speed	By pressing this key, the fan speed is gradually increased.
	Key Boost ventilation mode	By pressing this key, the boost ventilation is activated for 15 minutes in the supply air and extract air mode at the fan speed 7. After the expiration of the boost ventilation time, the previously active operating mode is activated. By pressing another function key, the boost ventilation mode can be cancelled at any time.
	Key Reset filter run-time	For cyclic filter checking, an operating hours counter is integrated in the control. The key Reset filter run-time is used for resetting the filter run-time.

	<p>Key combination activation / deactivation standby mode</p>	<p>By means of the standby function, the ventilation device is switched to an energy-saving mode. By pressing the – key several times until LED L1 goes off as well, the standby mode is activated. This state is signalled by the periodic blinking of the LED L8. When pressing the + key, the standby mode is terminated and the fan speed 1 is set. LED L1 is lit.</p>
	<p>Key combination configuration mode for joint operation with heat-producing appliance</p>	<p>By pressing the key combination for at least 3 s, the extract air mode is permanently deactivated. This state is signalled by the LEDs L8+L11+L12, L8 and L12 being lit, L11 blinking 2x and then remaining <u>off</u>. This signalling is only visible if the key combination is held down. An actuation of the key Extract air mode in deactivated condition leads to three short blinking of the LED L11, in order to signal the deactivated condition. If the key combination is pressed once again for at least 3 s, the key lock is deactivated. The change is signalled by the LEDs L8+L11+L12, L8 and L12 being switched on, L11 blinking 2x and then remaining <u>on</u>. This signalling is only visible if the key combination is held down. In this way, the extract air mode is possible again.</p> <p> The key Reset filter change must always be pressed in the first place!</p>
	<p>Key combination configuration mode for temperature threshold summer ventilation</p>	<p> The summer ventilation is with LED control panel only be executed if it is enabled in the factory settings.</p> <p>By pressing the key combination for at least 3 s, the configuration mode summer ventilation is activated and the LEDs L8 and L10 are blinking.</p>
	<p>Keys for setting</p>	<p>By means of the keys, the temperature threshold for the summer ventilation can be adjusted in dependency on the extract air temperature between 21 °C (LED L1) and 27 °C (LED L7). After the repeated actuation of the key combination for at least 3 sec, the setting is applied and the configuration mode for temperature threshold summer ventilation is closed.</p> <p> The key Reset filter change must always be pressed in the first place!</p>
	<p>Key combination configuration mode imbalance</p>	<p>By pressing the key combination for at least 3 s, the configuration mode imbalance is activated and the LEDs L10 and L12 are blinking. By means of the keys for balance setting, the balance of the fan speed which was active during the activation of the configuration mode imbalance can now be adjusted in steps of 5 %. The balance setting is not carried out separately for each fan speed, but jointly for groups of fan speeds.</p>
	<p>Keys for balance setting</p> <ol style="list-style-type: none"> 1. Group fan speeds <1+2> 2. Group fan speeds <3+4+5> 3. Group fan speeds <6+7> 	<p>The adjustable range is from -15 % (L1) to + 15 % (L7). In centre position (L4), the supply and extract air fans run at the same rotation speed. After having actuated the key combination once again, the setting is accepted and the configuration mode imbalance is terminated.</p> <p> The key Reset filter change must always be pressed in the first place!</p>

Tab. 2: Operating functions of the LED control panel

2.2.1.2 Signalling of operating and error conditions

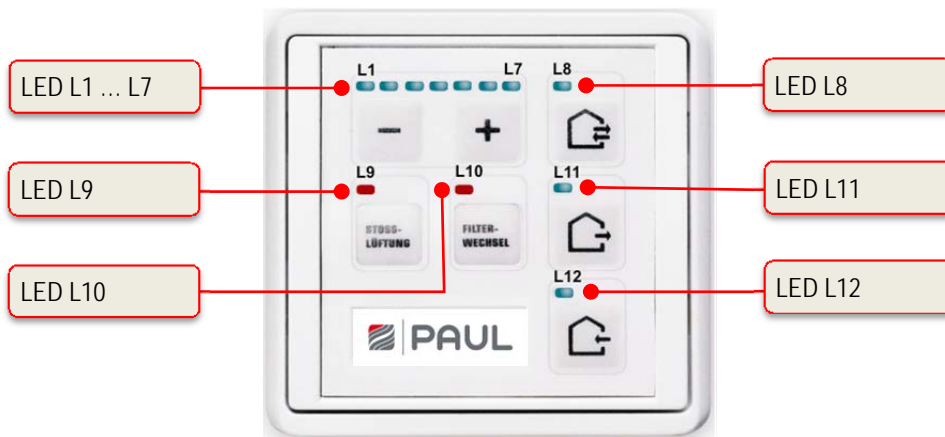

Fig 5: LED signaling of the LED control panel

LED signalling	Function / meaning
LED lamp display L1 ... L7	No LED \triangleq fan speed 0 (fan off, standby) 1 LED (L1) \triangleq fan speed 1 2 LEDs (L1 + L2) \triangleq fan speed 2 ... etc. 7 LEDs (L1 + L2 + ... + L7) \triangleq fan speed 7
L1 + L7 are lit	No external release: fan off
L8 is lit	Supply and extract air mode
L8 blinks	Error sensor: Fans are switched off
L8 flashes	Standby mode active
L8 + L10 blinks	Configuration mode temperature threshold summer ventilation
L8 + L11 + L12 blinken	General error, the error number is displayed in a binary form by means of the LEDs L1 to L7 (see Tab. 38 in section 3.8.1)
L8 + L12 are lit + L11 blinks 2x and then remains off	Configuration mode for joint operation with heat-producing appliance (display only during the configuration phase)
L9 is lit	Boost ventilation mode (L1 + L2 + L3 + L4 + L5 + L6 + L7 blink)
L10 is lit	Filter run-time has expired
L10 flashes	The remaining filter run-time is \leq 10 days
L10 + L12 blink	Configuration mode balancing for the selected fan speed (display only during the configuration phase)
L11 is lit	Extract air mode
L11 blinks	Error fan 1 Hall: Fans are switched off
L11 blinks briefly 3x	Extract air mode deactivated (key Exhaust air mode locked, configuration for joint operation with heat-producing appliance active)
L12 is lit	Supply air mode
L12 blinks	Error fan 2 Hall: Fans are switched off

Tab. 3: Assignment of functions of the LED signalling

2.2.2 TFT touch panel

The 3.5" TFT display of the touch panel is operated by touching the symbolised buttons with the fingers. The display of the active operating mode and the corresponding button are signalled in colour. The comfort edition of the control panel, as a TFT touch panel with a stainless steel frame, is designed for an in-wall installation.



The ventilation device can be operated with up to 3 control units type TFT touch panel or without control panel. A TFT touch panel is recommended for commissioning!

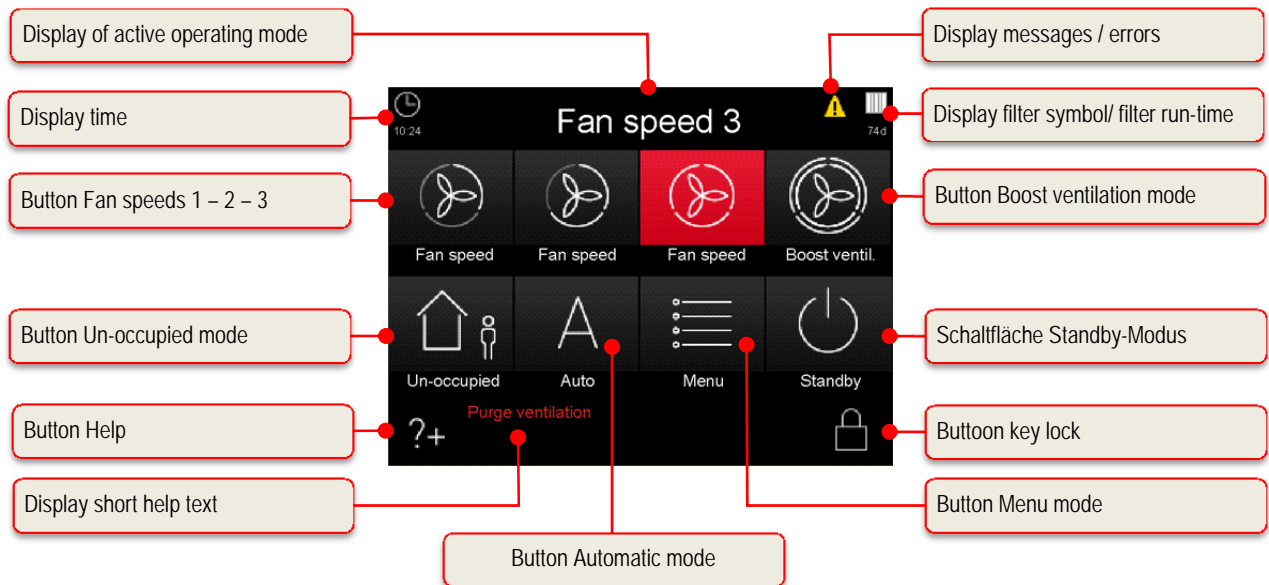





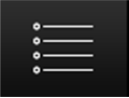

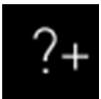









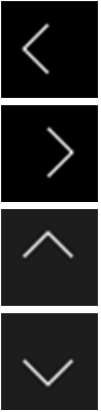

Fig 6: Buttons and information fields of the touchpad (startmenu)

2.2.2.1 Operating function and signalling of the TFT touch panel

Symbol	Designation	Explanation
-	Fan speed 0 (FS0)	The fans stand still. This fan speed is used in the functions Automatic timing mode and Un-occupied mode.
	Button Fan speed 1 (FS1)	By touching this button, the lowest permanent fan speed 1 is set.
	Button Fan speed 2 (FS2)	By touching this button, the medium permanent fan speed 2 is set. This fan speed is adjusted by the service technician during commissioning of the device in the setup menu. A balance between the supply and the extract air fan is adjusted.
	Button Fan speed 3 (FS3)	By touching this button, the highest permanent fan speed 3 is set.
	Button Boost ventilation mode	By touching this button, the boost ventilation mode is set. An automatic timing programme starts where the fan speed 3 is active during a pre-settable period of time (standard: 15 min factory setting).
	Button Un-occupied mode	By touching this button, the un-occupied mode is set. For non-occupation, a reduced ventilation intensity can be set for humidity protection by activating the un-occupied mode. In order to terminate this function, another button must be pressed.

	Button Automatic mode	The automatic mode has 2 automatic functions – automatic timing and automatic sensor. The manual settings are deactivated by touching the button.
	Automatic timing mode	By means of the automatic timing mode, different fan speeds (FS0, FS1, FS2 or FS3) can be defined for every day of the week with a resolution of 15 minutes. This “fan speed week profile” can be configured and individually adjusted in the menu Settings/submenu Automatic timing.
	Automatic sensor mode	The automatic sensor mode regulates the fans according to a pre-settable linear characteristic curve depending on an analogue indoor air quality sensor (also CO ₂ , air humidity and temperature combined).
	Button Menu mode	By touching this button, you reach the information, setting and setup menu.
	Button Standby mode	By means of the standby function, the ventilation device is switched into an energy-saving mode. In standby mode, the power consumption of the entire device decreases to less than 1 W. The screen display gets dark; however, the touchpad remains active in order to “wake up” the system. One touch of the touchpad suffices to terminate the standby mode.
		 According to DIN 1946-6, during the heating period, the plant must be in operation for at least 12 h/d and must not be switched off longer than 1 h each time!
	Button Help	By touching this button, you are redirected to a context-sensitive help menu. If this key is grey, no help text is stored.
	Button Activate key lock	By touching this button, the touchpad is deactivated, except for this button. The screen is dimmed and becomes inactive (cleaning status).
	Button Deactivate key lock	If it is touched again and held down (for approx. 2-3 s) you reach the start menu again.
	Button Checkmark	By touching this button, the desired or available parameter is selected or confirmed.
	Button Enter	By touching this button, it is possible to navigate in the different submenus. Changed parameters are copied into the memory.
	Button Cancel / back	By touching this button, you change from a menu into the next higher menu level without copying possibly changed data.
	Signalling messages	A flashing yellow warning triangle at the upper right edge symbolizes a piece of information or an error. These are registered in the menu Information/Current Message and errors additionally in the menu Information/Last Message.

	<p>Signalling filter symbol / filter run-time</p>	<p>For cyclic filter checking, an operating hours counter is integrated in the control. The operating hours are subtracted from the preset filter run-time by counting backwards and are displayed in days below the filter symbol. The filter symbol colour changes from white to yellow when the filter run-time is ≤ 10 d and from yellow to red when the filter run-time has expired.</p> <p>In case the filter run-time has expired, the message “Replace filter” is generated.</p>
	<p>Buttons + / -</p>	<p>By touching these buttons, values can be changed in the menus (e.g. fan speeds in steps of 1% or the time in steps of minutes or seconds).</p> <p> <i>The data is not copied until the Enter button is touched!</i></p>
	<p>Buttons Navigation</p>	<p>By pressing the Navigation buttons left/right and up/down, it is possible to navigate in the menus in order to select the desired parameter in the respective menu level. If more than one value can be set in one menu (e.g. for date and time: day, month, year, hours, minutes), it is possible to select the single values to be modified by means of the Navigation buttons and to modify them by pressing + / -.</p>

Tab. 4: Operating functions and signalling of the TFT touch panel

2.3 Menu structure of the TFT touch panel

The menu structure is made up of the start menu and three main menus (information, settings and setup). When activating the TFT touch panel, the start menu is displayed. The main menus are each divided up into submenus, allowing the access to information or parameter changes.

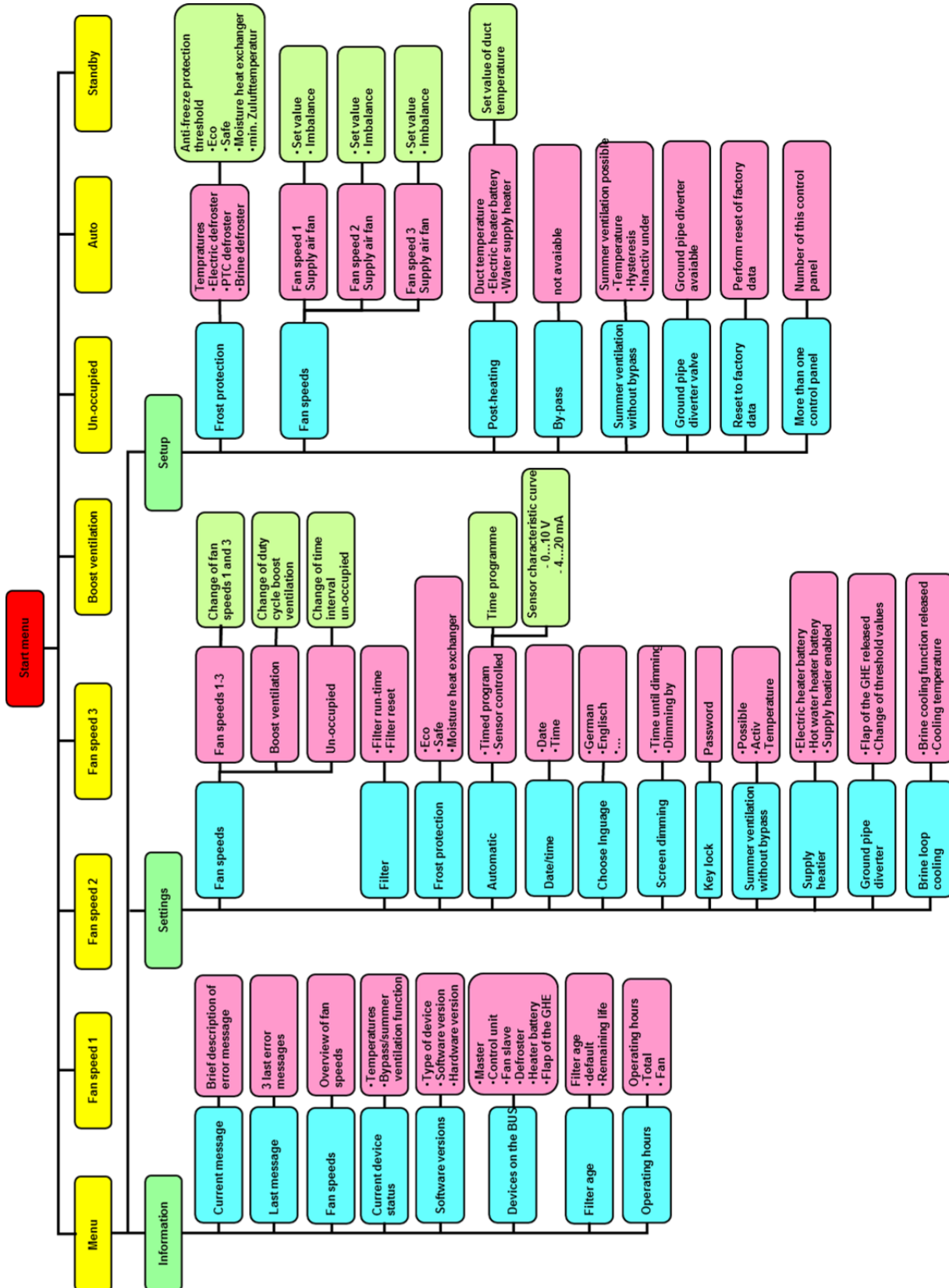

Fig 7: Menu structure of the TFT touch panel

2.3.1 Main menu Information

The main menu **Information** is divided into eight submenus. In the submenus, information on the current device status as well as selected factory pre-sets (e.g. type of device) are visualised. Using the navigation buttons, the respective menu is selected and called up with the Enter key.

2.3.1.1 Submenu Current message

Here, a piece of information (e. g. Replace filter) or an error (e.g. broken sensor) are displayed as current message. In addition to this display, a yellow warning triangle flashes in the upper right edge of the screen. Only error messages generally lead to switching off the fans.

2.3.1.2 Submenu Last messages

Here, the last three errors that occurred are registered in compliance with the event with date and time. In addition to this indication, a yellow warning triangle is flashing at the right upper margin of the screen.

2.3.1.3 Submenu Fan speeds

Here, the percentage adjustments of the three fan speeds 1, 2 and 3 (FS1, FS2 and FS3) as well as the pressed times for un-occupied and boost ventilation are indicated.

2.3.1.4 Submenu Current status of the device

Here, the current device-related supply air temperature and intake air temperature as well as the by-pass status (closed / open) for devices with by-pass flap or the summer ventilation status (inactive / active) for devices without by-pass flap are displayed

2.3.1.5 Submenu Software versions

In this menu, the devices which are actually connected to the bus and which were identified are displayed by means of checkmark symbols.

2.3.1.6 Submenu Connected devices

In this menu, the devices which are actually connected to the device-internal BUS and which were identified are displayed by means of checkmark symbols.

2.3.1.7 Submenu Filter age

Here, the pressed filter run-time and the current remaining run-time of the filter are indicated. The filter run-time is decremented daily.

2.3.1.8 Submenu Operating hours

The following information is displayed:

- Overall operating hours (time during which the device is connected to the power supply)
- Operating hours of the fans (time during which the fans are operating)

2.3.2 Main menu Settings

In the main menu **Settings**, changes by the user are possible which primarily serve the individual adjustment to the own comfort. Using the navigation buttons, the respective submenu is selected and called up with the Enter key, whereby only submenus with text highlighted in red can be parameterised.







The settings in the submenu are only applied after having touched Enter!

2.3.2.1 Submenu Fan speeds

Using the navigation buttons, the following can be selected and set here:

- Fan speed 1 and fan speed 3 (in 1 %-steps)
- Duration of the boost ventilation (in 5 min-steps)
- Ventilation intensity for non-occupation (FS1 in 15 min/h-steps)



Symbol	Designation	Explanation / actions
	Button Fan speed 1 (FS1)	Using the button Fan speed 1, activate FS1 and parameterise it with the navigation buttons. Setting range: 17 % < FS1 < FS2
	Button Fan speed 3 (FS3)	Using the button Fan speed 3, activate FS3 and parameterise it with the navigation buttons. Setting range: FS2 < FS3 < 100 %
	Duration boost ventilation	Settings: 15 min ... 120 min, whereby the air volume flow of the boost ventilation corresponds to fan speed 3.
	Ventilation intensity for the duration of non-occupation for humidity protection	Settings: 15 min/h, 30 min/h, 45 min/h, whereby the ventilation intensity of the active duration of the time interval corresponds to fan speed 1.

Tab. 5: Parameterization submenu fan speeds

2.3.2.2 Submenu Filter

The following can be set / read here:

- Filter run-time in 10-day-steps
- Current remaining run-time of the filter
- Retting of the filter run-time and the counter for exceeding the filter run-time

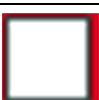
Symbol	Designation	Explanation / actions
	Duration of the filter run-time	Setting: 30 d ... 180 d, using the navigation buttons whereby a maximum filter run-time of 90 days is recommended.
	Remaining run-time of the filter	Display of the current remaining run-time of the filter
	Display field Reset filter run-time	Using the button Checkmark and Enter, the filter run-time can be reset to the pre-set value.

Tab. 6: Parameterization submenu filter

2.3.2.3 Submenu Frost protection

Here, the frost protection mode can be set using the navigation buttons:

- eco
- safe
- Moisture heat exchanger (enthalpy exchanger) with own anti-freeze protection threshold

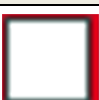
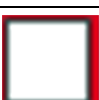
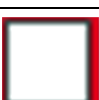
Symbol	Designation	Explanation / actions
	Display field Frost protection mode Eco	In this “eco mode” however, there is a residual risk of freezing of the heat exchanger. The energy required for frost protection is lower.
	Display field Frost protection mode Safe	In the “safe” mode, freezing of the heat exchanger is absolutely prevented. The energy required for frost protection is higher.
	Display field Frost protection mode Moisture heat exchanger	In the mode Moisture heat exchanger, freezing of an enthalpy exchanger (membrane moisture heat exchanger) is basically prevented.

Tab. 7: Parameterization submenu frost protection







2.3.2.4 Submenu Automatic

Two operating modes are provided in the automatic mode:

- Automatic timing
- Automatic sensor

The desired operating mode of the automatic mode is selected using the navigation buttons (red background of the text) and by setting the checkmark, and confirmed with Enter.

2.3.2.4.1 Automatic timing

Symbol	Designation	Explanation / actions
	Button Calendar	By touching the button Calendar, a weekday (Mon...Sun) or a group of weekdays (Mon-Fri; Sat-Sun) is selected, the desired fan speed is preselected.
	Button Fan speed 0 (FS0)	The fans stand still.
	Button Fan speed 1 (FS1)	Reduced ventilation
	Button Fan speed 2 (FS2)	Nominal ventilation
	Button Fan speed 3 (FS3)	Purge ventilation
	Cursor	The cursor marks the time in the ¼-hour-range. Using the navigation buttons, the cursor is navigated across the time slot in which the selected fan speed shall be active.

Tab. 8: Parameterization automatic timing

By selecting a group of days (e.g. Mon-Fri), the change data are assigned to each day of the group. Thus, the settings for the group “Mon-Fri” are then identical to the days “Mon”, “Tue”...“Fri” (or group “Sat-Sun” identical to days “Sat”, “Sun”). In order to operate the plant with fan speed profiles and time profiles that differ from day to day, the profile of the respective day (“Mon”...“Sun”) must be changed. Possibly further changes in the groups “Mon-Fri” or “Sat-Sun” overwrite the previously made settings of the individual days again!

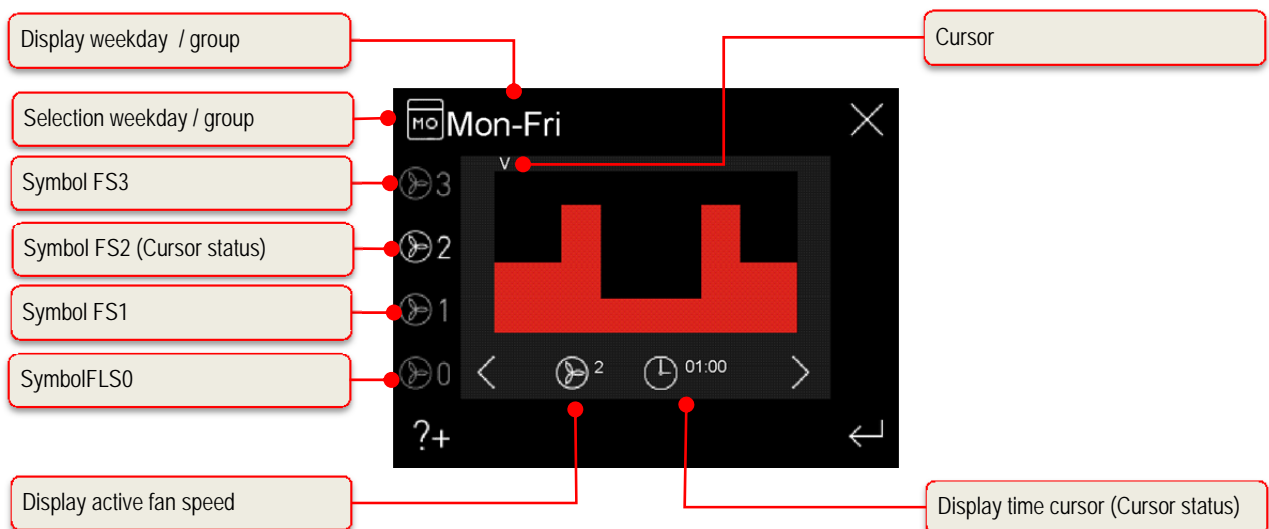

Fig 8: Automatic timing factory setting, group weekdays Mon-Fri

Fan speed (FS)	Time slot (time 0 ⁰⁰ - 24 ⁰⁰)	
FS1		8 ³⁰ - 16 ⁰⁰
FS2	0 ⁰⁰ - 8 ⁰⁰	16 ⁰⁰ - 24 ⁰⁰
FS3	8 ⁰⁰ - 8 ³⁰	

Tab. 9: Time slot factory setting, group weekdays Mon-Fri

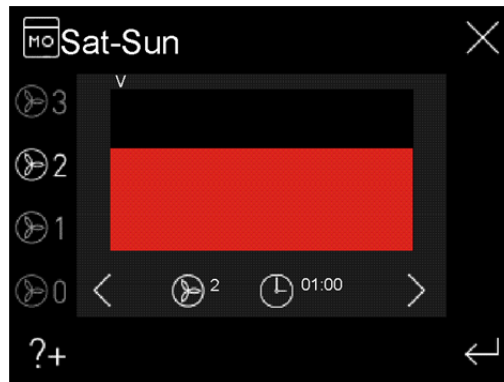

Fig 9: Automatic timing factory setting, group weekdays Sat-Sun

Fan speed (FS)	Time slot (time 0 ⁰⁰ - 24 ⁰⁰)	
FS2	0 ⁰⁰ - 24 ⁰⁰	

Tab. 10: Time slot factory setting, group weekdays Sat-Sun



The factory setting of the automatic timing can only be reactivated via the main menu Setup.

If the operating mode “Automatic timing” is active in automatic mode, the active fan speed (FS 1-3 only) is, in accordance with the time slot, visualised in grey on the start menu in addition to the icon Automatic mode.

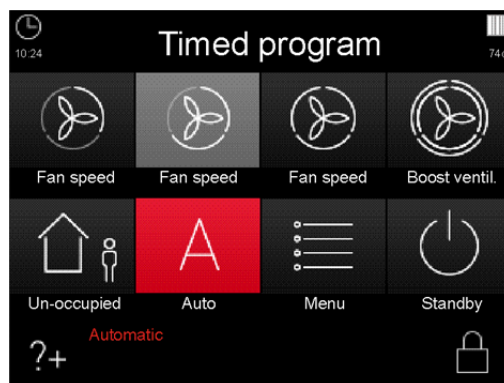

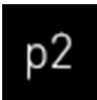

Fig 10: Automatic mode automatic timing with active fan speed FS2

2.3.2.4.2 Automatic sensor

The operating mode **Automatic sensor** of the automatic mode requires the connection of an external air quality / CO₂ or humidity sensor to the control of the ventilation device. The analogue signal of the sensor is taken as control signal for the fan rotary speed of the ventilation device. When applying several sensors in one ventilation plant, the output signal of a maximum value module is used for the control of the ventilation device. At first, using the navigation buttons (red background of the text) and by setting the checkmark, it is selected whether the sensor has a current output or voltage output (current: 4...20 mA, voltage: 0...10 V), and this is confirmed with Enter. Subsequently, the lower point (range start parameter p1) and the upper point (range stop parameter p2) of a linear characteristic curve for the fan speed are

parameterized between 17 % and 100 %. Using the navigation buttons, the characteristic variables (red background of the text) to be parameterised can be selected and the values can be set using the buttons + / -.

Symbol	Designation	Output signal sensor	
		0...10 V characteristic curve	4...20 mA characteristic curve
	Characteristic curve start value	Umin (V) \triangleq n_min (%)	Imin (mA) \triangleq n_min (%)
	Characteristic curve end value	Umax (V) \triangleq n_max (%)	Imax (mA) \triangleq n_max (%)

U-n- Characteristic curve graph

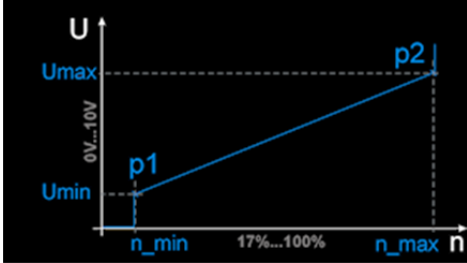

I-n- Characteristic curve graph

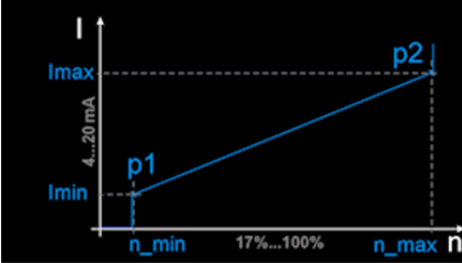

Tab. 11: Parameterization automatic sensor

Plausibility check for sensors with current output:

- Concerns the analogue input AI1 on the master controller (terminal X2.7 / X2.8)
- Error message if a value of 0...3 A is applied at the input for more than 1 s
- Reset error if I > 3.5 mA for at least 1 s

2.3.2.5 Submenu Date/Time

In this menu, date and time are set. Using the navigation buttons, the characteristic variables (red background of the text) to be parameterised can be selected and the values can be set using the buttons + / -.



2.3.2.6 Submenu Choose language

In this menu, the language for the TFT touch panel can be selected with the navigation buttons.

2.3.2.7 Submenu Screen dimming

In this menu, an individual screen brightness and the duration until the occurrence of dimming after non-operation can be set using the navigation buttons.



- Duration until dimming in 1 min-steps
- Dimming in 5 %-steps

Symbol	Designation	Explanation / actions
	Duration until dimming	Settings: 1 min ...10 min, until activation of dimming after last operation of the TFT touch panel
	Degree of dimming	Settings: 5 % ...95 %, relating to the basic brightness when the screen is active
	Button Light bulb	Using this button, the set dimming can be tested. The screen is dimmed for 5 seconds according to setting.

Tab. 12: Parameterization screen dimming

2.3.2.8 Submenu Key lock

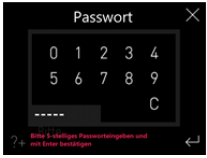
The user interface of the TFT touch panel can be deactivated with a password-protected key lock.

Symbol	Designation	Explanation / actions
	Password prompt	Entry of the password <11111> and confirmation with Enter. On the touch pad, "Key lock" is displayed as current status.
	Button Deactivate key lock	After touching the button, the user is prompted to enter the password for the deactivation of the key lock. Entry of the password <11111> and confirmation with Enter.

Tab. 13: Activation / deactivation key lock

2.3.2.9 Submenu Summer ventilation without by-pass

In ventilation plants with devices without by-pass flap the summer ventilation serves for free cooling. When activated, the exhaust air fan is switched off and a heat transfer from the extract air to the supply air is avoided. To check the temperature conditions for plausibility, the exhaust air ventilator is switched on for 2 minutes per hour in addition to the presently active fan speed.

This menu shows whether summer ventilation without by-pass is possible. The operating mode, summer ventilation, may or may not be released. Release of the summer ventilation function is selected with the button "Navigation" (red text backdrop), inserting the tick and pushing "Enter". Furthermore, the temperature threshold for activating the summer ventilation function can be set with the button "Navigation" (red text backdrop) and "+ / -".

When the boost ventilation mode is switched on during the active phase, the summer ventilation is interrupted during the time the boost ventilation is on.

Abbreviation	Designation	Explanation / actions
t_sum	Temperature threshold summer ventilation	Setting-range temperature threshold: 20 °C...30 °C The summer ventilation is active when temperature of the extract air exceeds the set temperature and the intake air temperature at the device is lower than the extract air at the device. In addition, the intake air temperature at the device has to be higher than the set limit of the outside air temperature

Tab. 14: Parameterization temperature threshold summer ventilation without bypass



In order to avoid the occurrence of draught from a too low temperature of the supply air, the summer ventilation remains inactive below an outside air temperature limit. The limit of the minimum outside air temperature can be set between 12 °C ... 20 °C in the main menu "Setup" (factory setting: 13 °C).

2.3.2.10 Submenu Supply heater

In this menu, an optionally available supplementary heating module (electric heater battery or hot water heater battery) is displayed. The function of the supplementary heating can be activated or deactivated. The release supplementary heating is selected using the navigation buttons (red background of the text) and by setting the checkmark, and is confirmed with Enter.

2.3.2.11 Submenu Ground pipe diverter

In this menu, an optionally available flap of the geothermal heat exchanger is displayed. The function of the flap of the geothermal heat exchanger can be activated or deactivated. The release flap of the geothermal heat exchanger is selected using the navigation buttons (red background of the text) and by setting the checkmark, and is confirmed with Enter. Furthermore, the temperature thresholds for switching of the flap of the geothermal heat exchanger can be selected using the navigation buttons (red background of the text) and can be set using the buttons + / -.

Abbreviation	Designation	Explanation / actions
t_out_max	Maximum outside temperature	Setting range upper threshold: 15 °C...30 °C If the outside temperature is above the set threshold value, the flap of the geothermal heat exchanger opens the intake air duct for cooling the outside air. → cooling function
t_out_min	Minimum outside temperature	Setting range lower threshold: -10 °C...14.5 °C If the outside temperature is below the set threshold value, the flap of the geothermal heat exchanger opens the intake air duct for heating the outside air. → frost protection function

Tab. 15: Parameterization temperature thresholds flap of the geothermal heat exchanger

2.3.2.12 Submenu Brine loop cooling

In this menu, an optionally available brine defroster is displayed. The cooling function of the brine defroster can be activated or deactivated. The release of the brine defroster is selected using the navigation buttons (red background of the text) and by setting the checkmark, and is confirmed with Enter. Furthermore, the temperature threshold for the cooling function can be selected using the navigation buttons (red background of the text) and can be set using the buttons + / -.

Abbreviation	Designation	Explanation / actions
t_bde	Threshold temperature brine defroster	Setting range: 15 °C...30 °C Brine loop system cooling will be activated when the intake temperature is above the set threshold cooling temperature. → cooling function

Tab. 16: Parameterization temperature threshold brine defroster

2.3.3 Boost ventilation mode with external boost ventilation sensing device

In most cases, boost ventilation sensing devices are mounted in exhaust air rooms such as bathrooms, W.C.s or kitchens in order to activate temporary maximum ventilation in these rooms for fast discharge of increased moisture and odours.

When operating this control element, the functional properties and visualisations described for the boost ventilation mode with LED control panel or TFT touch panel are generated. The boost ventilation mode is started again at each activation and interrupts the current operating mode for the duration set. Following this, the device switches back to the previously active operating mode. Manually switching the operating mode by means of connected control panels stops the boost ventilation function.

2.4 Maintenance by the operator

Maintenance of the ventilation device and plant by the operator is limited to the periodic change of the filters and cleaning of the supply and extract air valves. The filter must be checked every 3 months and changed if necessary, however, at least every 6 months.

In this context, also check other filters available inside the ventilation plant and change them if necessary. A replacement or cleaning of the filter mats at the extract air valves (e.g. bathroom, kitchen, W.C.s) should be carried out every 2 – 3 months or at your own discretion when checking the degree of soiling.



If maintenance work is not carried out regularly, this impairs the functioning of the comfort ventilation in the long term!

2.4.1 Replacement of the filter



The plant must not be operated without filter. During filter replacement and maintenance work, the ventilation device must be switched off!

Two high-quality original filters of the manufacturer are installed inside the FOCUS. After the corresponding message of the control panel or after visualisation of a programmed digital output signal, the filters in the FOCUS shall be checked. In order to do so, proceed as follows:

1. Switch the device to standby mode or disconnect it from the power supply.
2. Press both spring locks **A** and unlock with it the front plate.

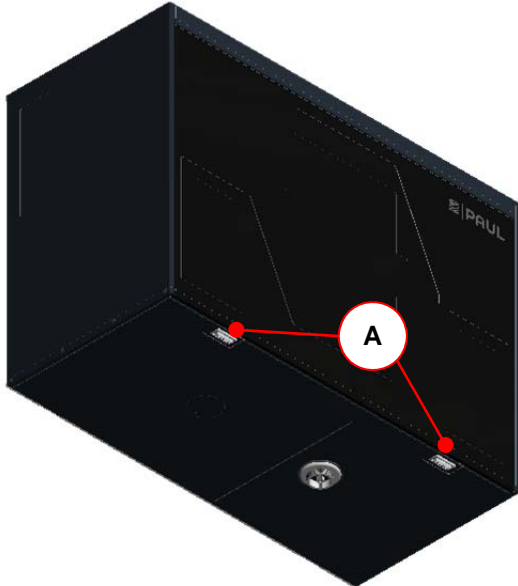

Fig 11: Press of the spring locks

3. Remove the front plate **B** gradually according to the directions of the arrows. Open the front plate in a corner from maximally 15 ° and hang them from the tin fold of the housing.

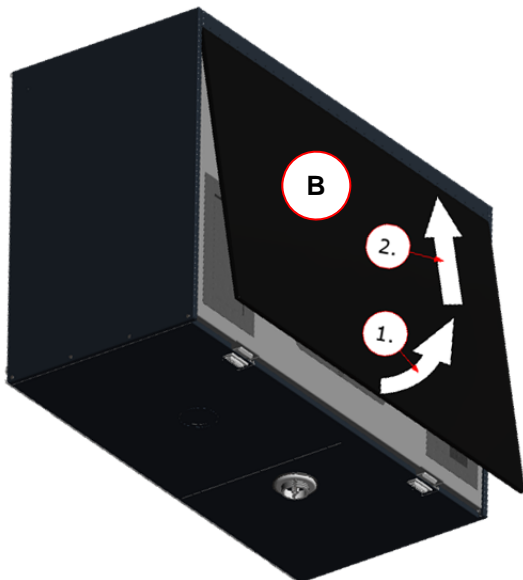

Fig 12: Opening the front plate

4. Pull by means of pull band **C** the foam material cover **C** of the filters and the heat exchanger from the foam material housing. Besides, take the pull band at one of the ends and go, besides, counter hold the device with the other hand.

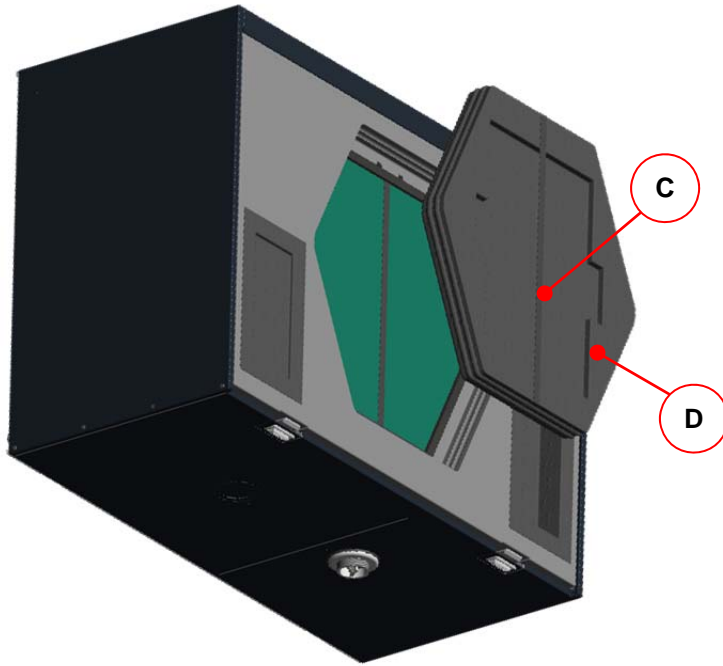

Fig 13: Dismantlement of the foam cover for filter and heat exchanger

5. Pull the filters out of the filter slide-in compartments by means of the filter strap E.



The filters are marked with an arrow according to the required flow direction!

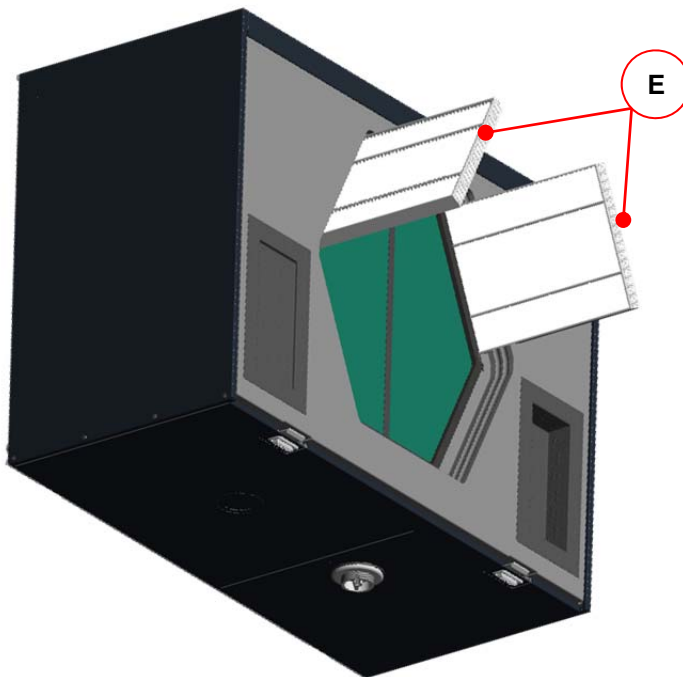

Fig 14: Pull out the filter

- Push the new filters in the filter slide-in compartments with regard to the flow direction **G**. The filters are marked with an arrow according to the required flow direction.

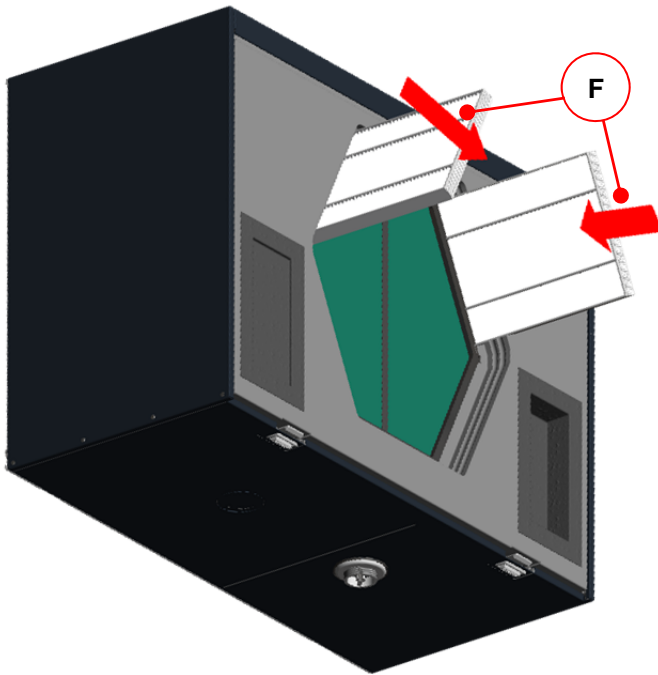
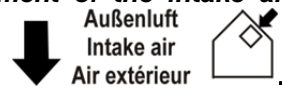

Fig 15: Install the new filter



Pollen filters are to be inserted in the filter slide-in compartment of the intake air

connection! The intake air connection is marked with the symbol





- Close the filter insertion fields and the heat exchanger with the foam cover.
- Hang the front plate in the tin fold of the housing, and press the front plate in the area of the spring locks to the housing to this in the spring locks engages.
- Re-establish the mains connection.

2.4.2 Resetting the filter run-time







Once the filter has been changed, the counter for the filter run-time must be reset. Resetting the filter run-time can be performed using the respectively connected control unit or the digital input signal (programmable with PC software as special solution).

2.4.2.1 Resetting the filter run-time by means of the LED control panel

Symbol	Designation	Explanation / actions
	LED 10 Signalling Filter run-time	When the LED 10 lights up, the filter run-time has expired and a filter check shall be performed.
	Key Reset Filter run-time	By pressing this key for at least 3 s, the filter run-time is reset. The LED 10 goes off. The timer starts the set filter run-time.

Tab. 17: Resetting the filter run-time by means of the LED control panel

2.4.2.2 Resetting the filter run-time by means of the TFT touch panel

Symbol	Designation	Explanation / actions
	Signalling Filter run-time expired	In case the filter run-time has expired, the message "Replace filter" is generated, signalling that the filter must be checked.
	Button Menu mode	By touching the button Menu mode, you reach the main menus
	Buttons Navigation	Select the main menu Settings by touching the Navigation buttons and confirm by pressing the Enter button.
	Buttons Navigation	Select the submenu Filter by touching the Navigation buttons and confirm by pressing the Enter button.
	Button Checkmark	By touching the Checkmark button, resetting of the filter run-time is selected.
	Button Enter	Confirm by pressing the Enter button.
	Button Cancel / back	By touching the Cancel / back button, exit the menu levels until the start menu appears.

Tab. 18: Step sequence resetting the filter run-time by means of the TFT touch panel



All maintenance work performed must be documented in check list A!

2.4.3 What to Do in the Event of a Failure?

Please contact the installer immediately in the event of a failure. Make a note of the error display and the failure code respectively. Also note down the type of your FOCUS, for that purpose, see type plate on the side of the device.

The mains connection must always be available, unless the FOCUS must be put out of operation due to a serious failure, maintenance work or for other imperative reasons.



As soon as a power disconnection has been performed, the living space is not mechanically ventilated anymore. This may cause moisture and mould problems in the living space. Therefore, the long-term shutdown of the FOCUS has to be avoided!

For the period of absence, the plant should be operated at the lowest fan speed or in the un-occupied mode!

2.5 Disposal

When the life time cycle of your FOCUS has expired, the company PAUL Wärmerückgewinnung GmbH offers you free take-back. If you do not make use of the possibility of feedback of recyclable product parts into the cycle of materials, we would like to remind you that the FOCUS must not be disposed of in the normal household garbage. For this kind of disposal, please obtain information on the possibilities of reuse of components or the eco-friendly treatment of the materials from you community.

3 Hints for qualified personnel

This section describes how to install and commission the FOCUS, how to analyse errors and how to carry out special maintenance work.

3.1 Prinzipal configuration of the system

CAPTION:

- T1 Sensor - device-internal temperature sensor
- T2 Sensor - device-internal temperature sensor
- T3 Sensor - device-internal temperature sensor
- T4 Sensor - device-internal temperature sensor
- T5 Sensor outside temperature
- T6 Sensor brine defroster
- T7 Sensor supplementary heater battery temperature
- T8 Sensor room temperature thermostat
- t_out outside temperature
- t_int intake air temperature
- t_sup supply air temperature
- t_ext extract air temperature
- t_exh exhaust air temperature
- t_bde inlet temperature brine defroster
- t_shb outlet temperature supplementary heater battery
- t_rth temperature of the thermostat

Note:

The internal temperature sensors T1...T4 are interpreted as follows by the software of the fan controller:

	version LEFT	version RIGHT
intake air	T1	T3
supply air	T2	T4
extract air	T3	T1
exhaust air	T4	T2

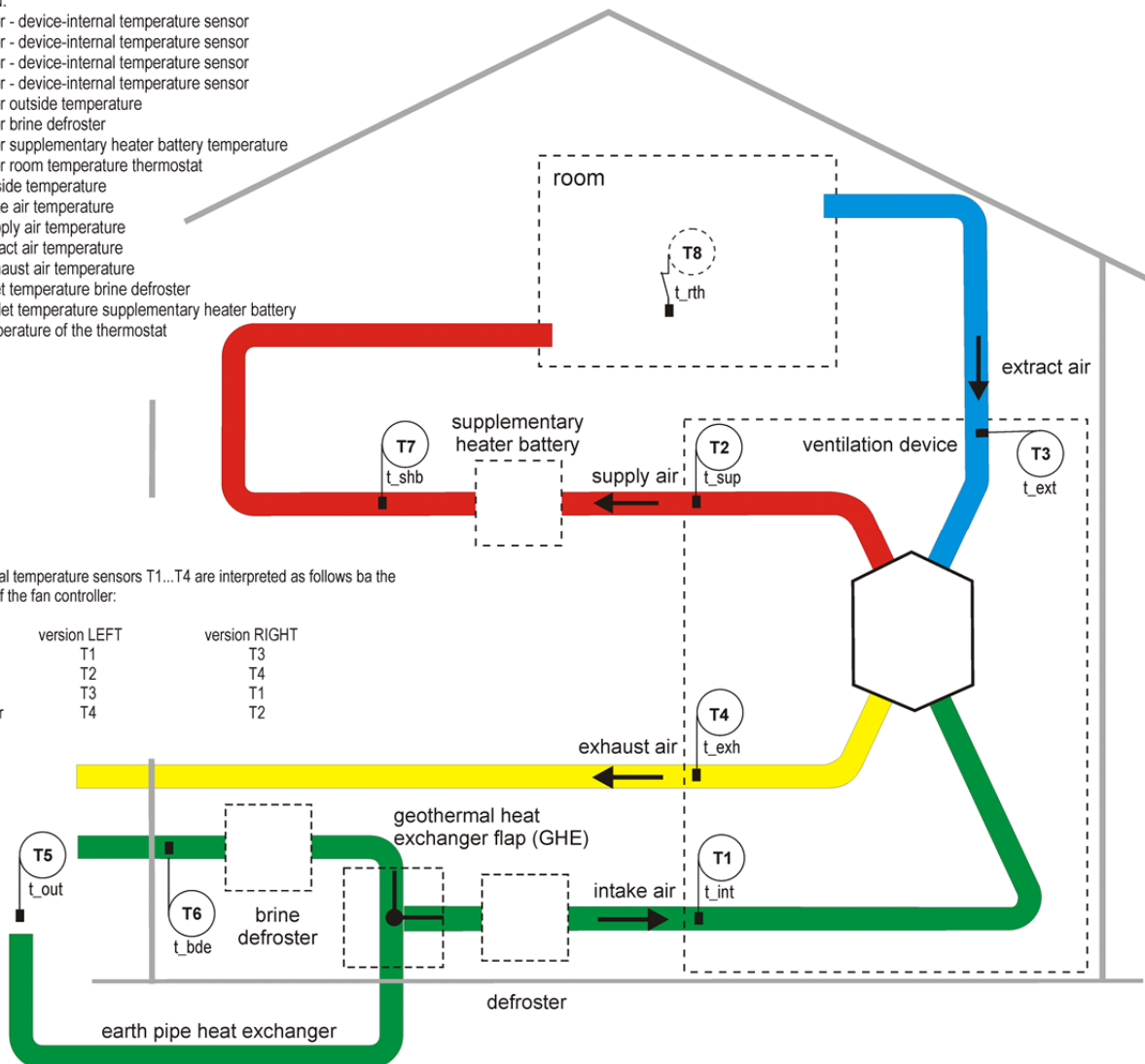

Fig 16: General system outline with FOCUS, version LEFT



The basic configuration of the system is universally valid and does not represent the system outline of the project-related ventilation plant! It is designed for representation of the plant-specific system structure for sensors and ventilation equipment.

3.2 Installation requirements

For proper installation, the following requirements must be fulfilled:

- Assembly in accordance with the general and on-site safety and installation instructions, amongst others of the electric power station and water works as well as in accordance with the instructions contained in this operating manual.
- Frost-free room in the interior
- Voltage supply 230 Vac, 50-60 Hz
- Sufficient space for air duct connections and maintenance work

3.2.1 Transport and packing

Proceed with care when transporting and unpacking the FOCUS.



The packaging of the device may only be removed immediately before assembly! Prior to and during assembly interruptions, the open air duct connection stubs must be protected with the caps of the air connection against ingress of construction dust and moisture!

3.2.2 Checking of the scope of delivery

If you detect any damages or incompleteness to/of the delivered product, please contact the supplier immediately. The scope of delivery includes:

- HRU FOCUS,
Check the type plate and make sure that it is the correct device (type / version / design);
- Mounting sheet with 2 pieces of self-adhesive rubber buffer;
- 230 V power cable with IEC power connector;
- CAT5 cable;
- Adapter plate;
- Box adapter board made of transparent plastic;
- Control panel(s), type and quantity of order dependent;
- Operating manual;
- Mounting frame (option).

3.3 Mounting

The FOCUS has to be mounted horizontally. During the wall mounting check the required load capacity of the wall construction (dead load of FOCUS 25 kg) and the safe mounting option of the mounting sheet. For inapplicable walls we recommend to apply the mounting frame for installation on the floor (available as an option). In this way possible transmissions of structure-borne noise are avoided as good as possible.



Ensure that a minimum clearance of 1 meter remains in front of the FOCUS for subsequent maintenance works.

3.3.1 Wall mounting

Thereby, processed the wall mounting as follows:

1. Mount the delivered mounting sheet **A** with the tongues **B**, which point upwards, horizontally to the wall. Take advantage of the long-quercher **C** for fixation by suitable fastening material.

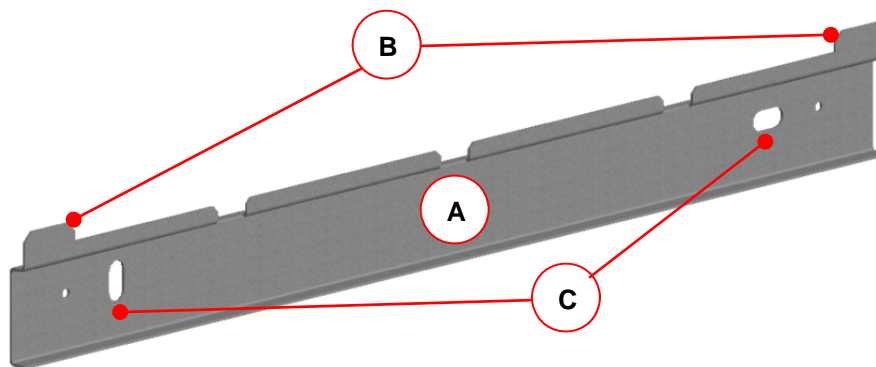

Fig 17: Mounting sheet for wall mounting



Note depending on the installation location, the required minimum clearances to finished floor!

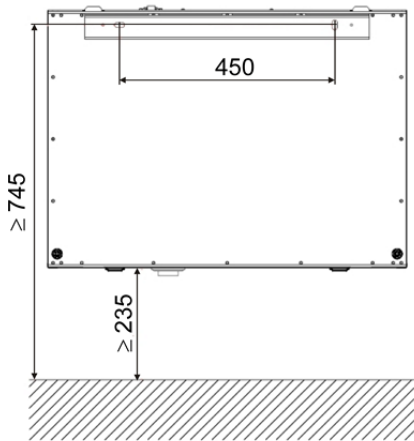

Fig 18: Wall mounting position to the finished floor (version LEFT)

2. Glue each piece of the enclosed, self-adhesive rubber buffer **D** in the bottom corner region on the rear panel of the device.

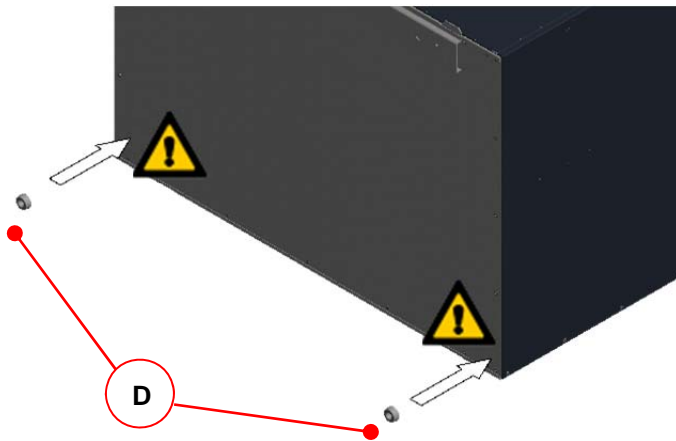

Fig 19: Mounting of the rubber puffer

3. Hang the FOCUS on the mounting sheet by hooking the tongues **B** in the slot openings **E** each of which are situated at the top of the fold of the rear panel.

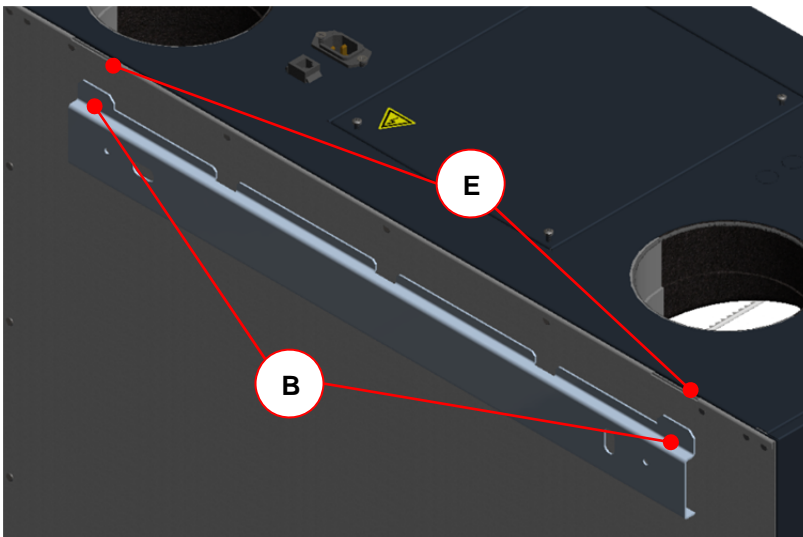

Fig 20: Hanging into the mounting sheet

3.3.2 Mounting on a mounting frame

The area of the mounting frame has dimensions of 620 x 292 mm and is vertically adjustable between 280 mm and 320 mm using mounting frame feet. The mounting frame consists of two long side parts with the frame feet and two short side parts.

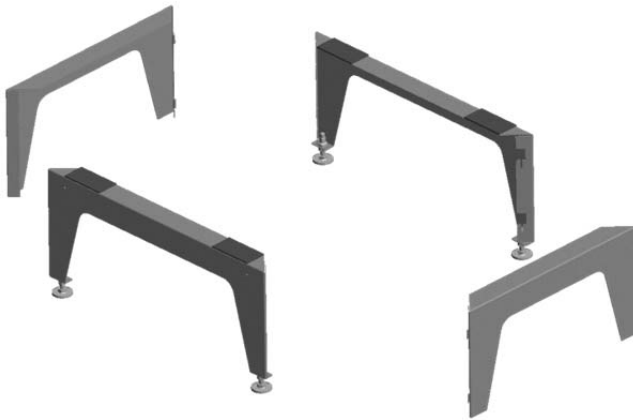

Fig 21: Parts of the mounting frame

Mount the individual parts of the mounting frame in accordance with the figures. Thereby, proceed as follows:

1. The short side part is vertically offset and to set at right angles to the long side part in direction of arrow.

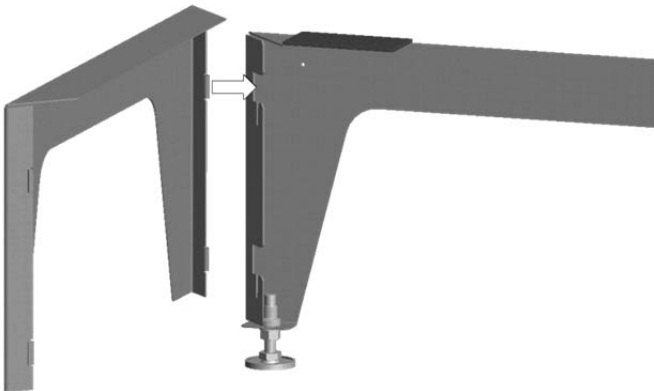

Fig 22: Put together the footboards

2. The tongues **A** of the short part are snapped into guiding slots **B** of the long part to fix both parts together in direction of the arrow.

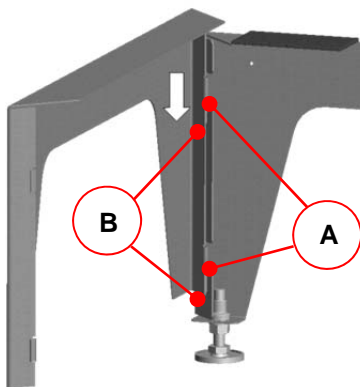

Fig 23: Fixing of the footboards

3. Now insert both the other two footboards together.

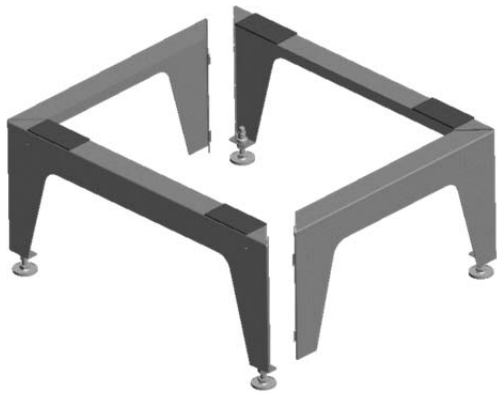

Fig 24: Each two together fixed footboards

4. Mount the mounting sheet **C** with the tongues, which point upwards, to a long side part of the mounting frame **F**. In doing so, screw both of the sheet metal screws **D** in the designated bore holes **E** of the side part.

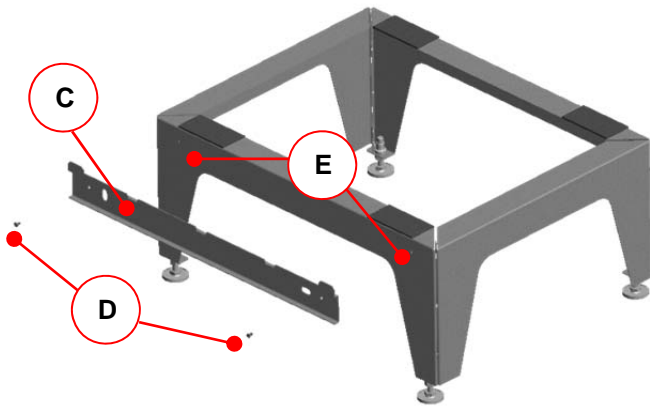

Fig 25: Screwing of the mounting sheet to the mounting frame

5. Now adjust the completed mounting frame perpendicularly and stably to the designated floor space via the height-adjustable feet **F** of the mounting frame.

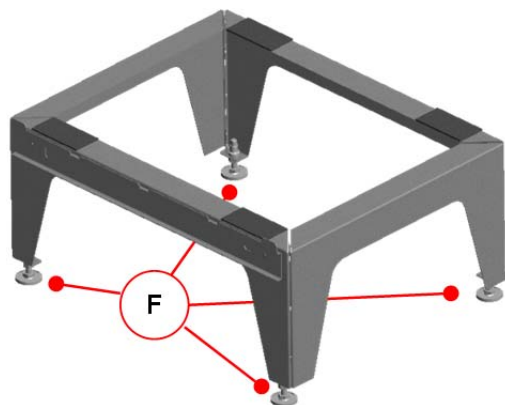

Fig 26: Adjust the mounting frame

6. Put the FOCUS on the mounting frame by hooking the tongues in the bottom slot openings of the rear panel. See Fig 20

3.3.3 Air duct connection

Observe the following points when mounting the air ducts:

- Mount the air duct types of the ventilation device to the connector stubs in accordance with the present LEFT or RIGHT device version (see tag next to the cover sheet control).

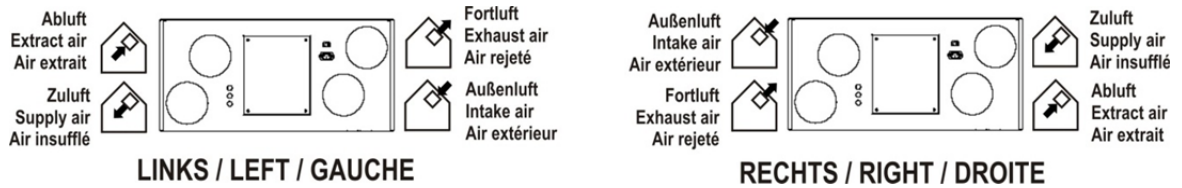

Fig 27: Layout air ducts version LEFT and version RIGHT

- Remove the caps of the air connection;
- Use air duct material with air resistance as low as possible, and connect the ventilation components air-tight among each other;
- The connection stubs of the device are made of EPP and have sleeve dimensions DN 125;
- The intake air and exhaust air ducts must be insulated in such a way that they are vapour-diffusion tight;
- In the event that a low point is unavoidable when installing the exhaust air duct from the device's exhaust air stub to the exhaust air outlet, a connection for condensate drain must be provided at that point;
- A straight pipe routing of the exhaust air from the device connection stub to the roof hood should be avoided, since during defrosting of possible ice formations, they might fall onto the blades of the exhaust air fan and cause damage to these blades;

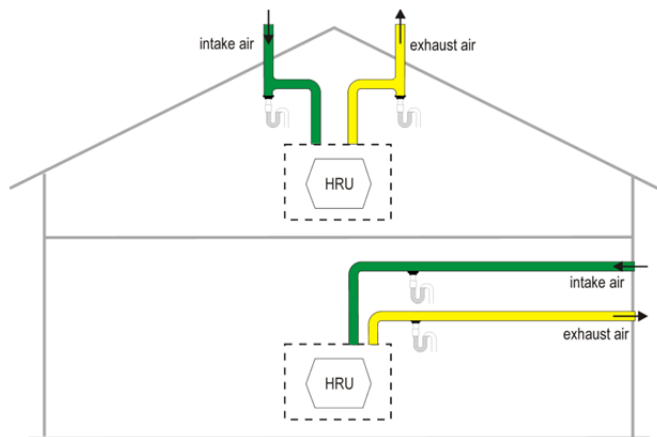

Fig 28: Arrangement drainage of the intake air duct and exhaust air duct

- If a silencer is provided at the exhaust air stub, it must be guided upwards by means of a bend in order to protect it against drenching caused by condensate returning from the exhaust air duct.
- If the exhaust air is guided over the roof, this guidance must be equipped with a double-wall or insulated roof lead-through. Thus, condensate formation between the roof boards is prevented.
- For the supply and extract air ducts, we recommend a thermal and vapour resistant insulation in order to avoid unnecessary temperature loss both in summer and winter.

3.3.4 Connection of the Condensate Drain

The warm extract air is cooled by the intake air in the heat exchanger. Thus, the moisture of the room air condenses in the heat exchanger. The condensate which forms in the heat exchanger is conducted to the siphon. The connector **A** of the condensate drain has an external thread of 1¼ inch. It is situated at the bottom side of the FOCUS in accordance with the respective device version.



Fig 29: Connector of the condensate drain version LEFT

A siphon has to be mounted to the 1¼-inch external thread of the condensate connection stub in such a way that the minimum 60 mm requirements of the liquid gauge heights are met in accordance with the schematic diagram.

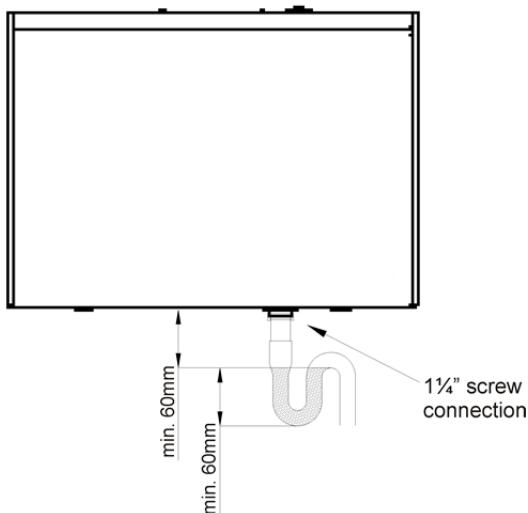

Fig 30: Condensate connection (Version LEFT)



The condensate drain must not be directly connected to the sewage system (e.g. finishing freely in a hopper with a siphon at the sewer).

Siphons can dry up! Water has to be refilled if:

- the device is commissioned
- the siphon makes noises (slurping)



A dry siphon is recommended, particular when using the enthalpy exchanger! (no limitation of the functionality if drying up)

3.4 Electrical connections



Electrical connections must be established in accordance with the applied standards to electrical equipment and only by qualified personnel!

The electrical power supply of the FOCUS is provided via the 3-pole plug connection **A** of a lower power device by means of the power cable. The CAT5 network cable is connected to the RJ45 jack **B**. Both plug connections are arranged on the surface of the device next to the cover sheet control. The cover sheet control is fastened with 4 screws **C**. Analogue and digital input / output signals of sensors (e.g. indoor air quality sensors) or actuators (e.g. boost ventilation switch) are connected to the respective terminal points of the master controller **D**. The cable bushings pre-cut **E** in the casing panel must be broken out as needed and the cables of the sensors / actuators must be guided through cable glands M16.

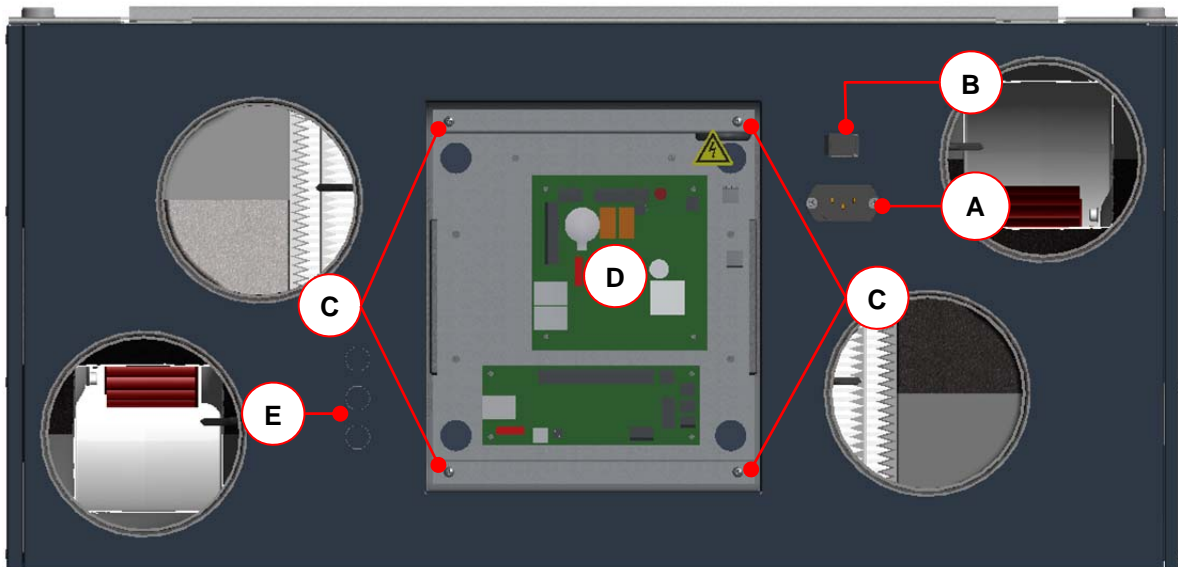

Fig 31: Surface of the electrical connections

Position	Bezeichnung
A	3-pole IEC connector
B	RJ45 jack
C	Screw (4x)
D	Master controller
E	Pre-cut cable bushing (3x) for cable gland M16
-	Plant 1 circuit diagram FOCUS
-	Plant 2 terminal scheme master controller

Tab. 19: Assignment of the electrical connections



The RJ45 jacks are exclusively serve the components of the internal RS485-BUS! Any other usage results in the damage of the control modules!

3.4.1 Connection of the adapter board

The adapter board with the 2-fold RJ45 plug connection and the 5-pole screw terminal X1 is used for communication of the modules via the internal RS485-BUS. The CAT5 network cable establishes the internal connection between the RJ45 jack of the FOCUS and one of the two RJ45 jack of the adapter

board internal connection between the RJ45 jack of the FOCUS and one of the two RJ45 jack of the adapter board.

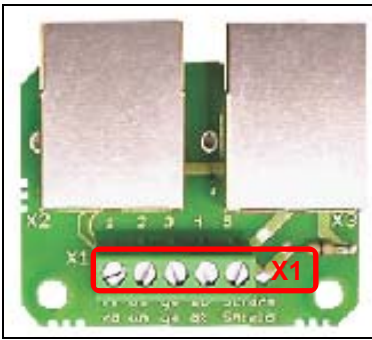

Fig 32: Adapter board

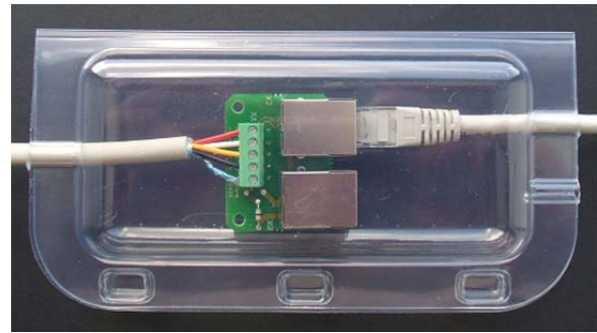

Fig 33: Casing for adapter board

A screened 4-wire cable is connected to the 5-pole screw terminal of the adapter board. This cable connects the adapter board to the 5-pole screw terminal of the control unit's adapter board. In order to be protected against error voltage, short circuit and dust, the adapter board must be mounted into the casing made of transparent plastic. The cables connected to the adapter board must be placed into the cable troughs of the casing and are fastened by means of the 3-fold click lock of the hinged cover. It is recommended to use a cable of the type J-Y(ST)Y 2x2x0.6 LG internal cable with a colour coding according to VDE0815 acc. Tab. 20.

Terminal X1 (adapter board / control unit)	Wire	Signal
X1.1	red	24P
X1.2	white	RX
X1.3	yellow	TX
X1.4	black	GND
X1.5	aluminium-coloured	screen

Tab. 20: Terminal assignment for terminal X1 adapter board and terminal X1 control unit

3.4.2 Connection of the TFT touch panel

The cable of the type J-Y(ST)Y 2x2x0.6 must be connected to the terminal X1 of the adapter board acc. Tab. 20. The ribbon cable connects the adapter board to the board of the TFT touch panel.

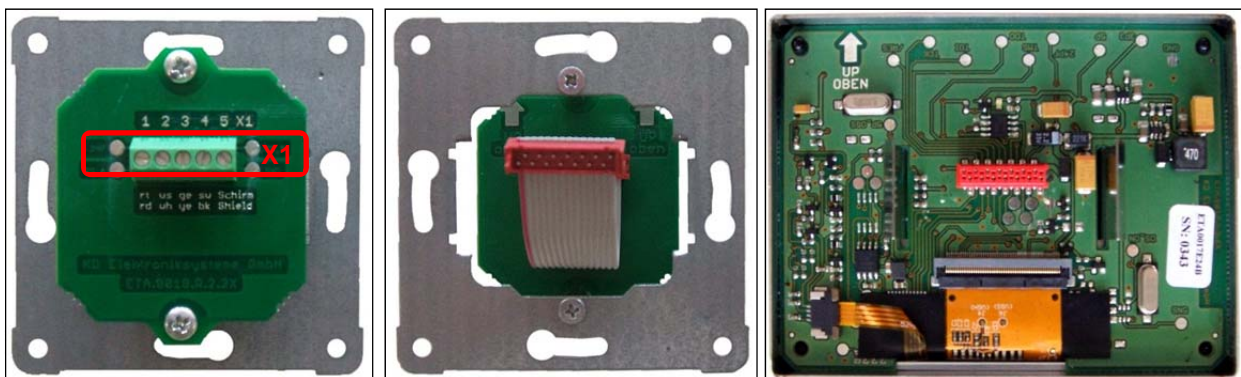

Fig 34: Adapter board with terminal X1 on an in-wall base plate; ribbon cable of the adapter board; board of the TFT touch panel (from left to right)



The connectors of the ribbon cable which are protected against polarity reversal must be carefully plugged into the jacks of the respective boards!

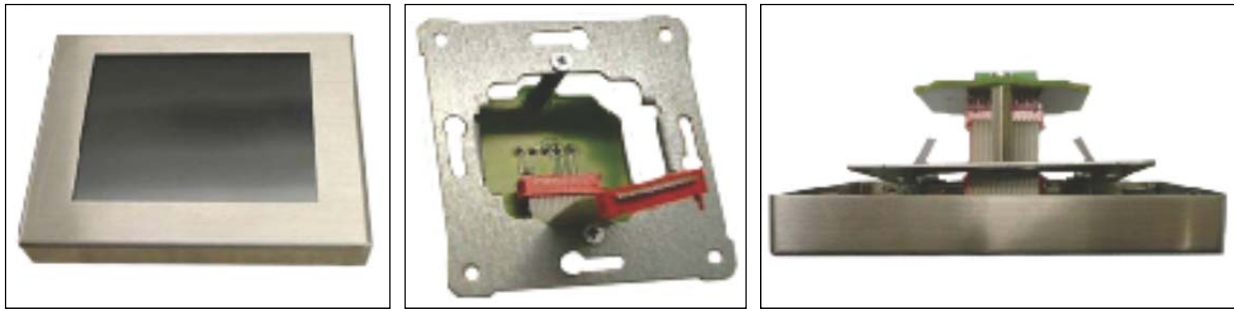

Fig 35: Touchpad with stainless steel frame; ribbon cable of the control unit adapter; Touchpad engaged in the in-wall base plate (from left to right)

The smaller side of the stainless steel frame of the ready-made TFT touch panel has to point upwards. In doing so, the control unit adapter and the in-wall base plate have to be positioned in such a way that the ribbon cable of the control unit adapter, which is arched downward, is plugged in the TFT touch panel. The spring steel clips, which are mounted to the rear side of the control unit, grasp the in-wall base plate and pull the stainless steel frame of the control unit tightly to the wall.

3.4.3 Connection of several TFT touch panels

It is possible to connect up to three TFT touch panels as control units for the ventilation device. On the hardware side, the TFT touch panels shall be connected in parallel to the terminal X1 of the adapter board according to conductor assignment Tab. 20. The TFT touch panels shall be successively commissioned and re-addressed (factory setting default address = 1). Addressing of the TFT touch panels is performed at software level in the setup/submenu More than one control panel.

Symbol	Designation	Explanation / actions
	Address two TFT control panels	Connect the first TFT touch panel
	Button Menu mode	By touching the button Menu mode, you reach the main menus.
	Buttons Navigation	By touching the navigation buttons, select the main menu setup and confirm with Enter.
	Button Password	Password prompt Enter the password _ _ _ _ _ and confirm with Enter.
	Buttons Navigation	By touching the navigation buttons, select the submenu Several control panels and confirm with Enter.
	Buttons Navigation	By touching the navigation buttons, select the address number 2 and confirm with Enter.
		Connect the second TFT touch panel Sequence of steps for software addressing not applicable since address number = 1 (factory setting)
	Address three TFT control panels	Connect second TFT touch panel Perform the sequence of steps for software addressing as before, assign address number 3.
		Connect third TFT touch panel Sequence of steps for software addressing not applicable since address number = 1 (factory setting)

Tab. 21: Sequence of steps connection / addressing of several TFT control panels



The connection of several control panels with the same address number results in a communication error!



The operation mode of the ventilation device is based on the last input instruction at one of the TFT touch panels connected.

3.4.4 Connection of the LED control panel

The operation of the ventilation device is only possible with **one** a control unit type LED control panel. The cable of the type J-Y(ST)Y 2x2x0.6 must be connected to the terminal X1 or the adapter board in accordance with Tab. 20. The ribbon cable connects the adapter board with the board of the LED key-pad.

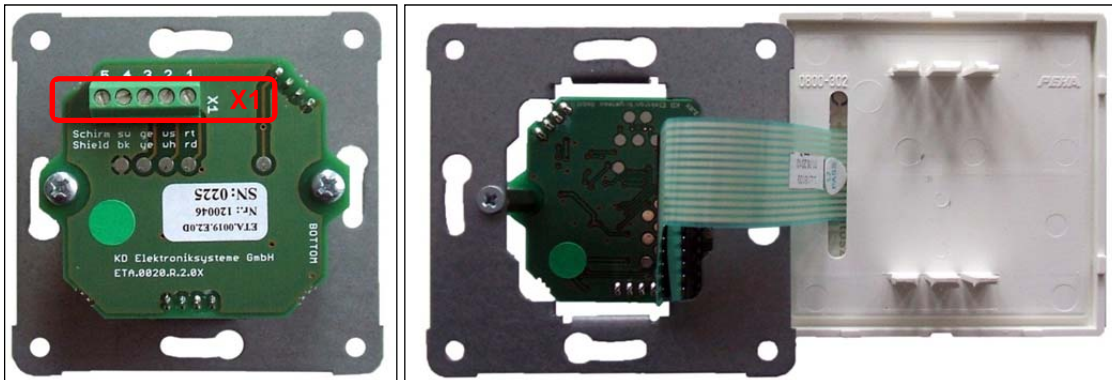

Fig 36: Adapter board with terminal X1 on an in-wall base plate; ribbon cable of the adapter board; rear panel LED key-pad (from left to right)



Do not pull the ribbon cable off the adapter board, but put the LED control panel diagonally through the PEHA frame!

3.4.5 Connection of external boost ventilation switch

The boost ventilation mode can be activated by actuating one or more boost ventilation switches connected in parallel. The switches which are usually installed in the design of the respectively used switch range are triggered when the boost ventilation mode is activated. The potential-free connection between the sensor and the master controller is established by means of a cable with at least 2 wires (recommendation: cable type J-Y(ST)Y 2x2x0.6). The introduction of the cable in the FOCUS is realised in one of the pre-cut cable bushings.

Terminal X1 master controller	Wire cable boost ventilation switch
X1.12	Wire 1
X1.13	Wire 2 (GND)

Tab. 22: Terminal assignment connection boost ventilation switch

3.4.6 Connection of external sensors

The operating mode **Automatic sensor** auf the automatic mode is controlled by an analogue sensor signal which is generated by one or more sensors. The connection between the sensor module and the master controller is established by means of the cable prescribed for the transmission of the sensor signal. The introduction of the cable into the FOCUS is realised in one of the pre-cut cable bushings.

Terminal X2 master controller	Wire cable sensor module
X2.7 (analogue input1)	Wire 1 (sensor signal 0...10 V or 4...20 mA)
X2.8 (GND)	Wire 2 (GND)

Tab. 23: Terminal assignment connection analogue sensor signal

3.4.7 Connection status relay

A status relay on the master controller indicates the operating status of the fans (factory setting).

Fan off: Contacts open
Fan on: Contacts closed

Terminal X1 master controller	Contact designation
X1.9	Normally open contact status relay (max. 24 V switching voltage)
X1.10	Change over contact status relay (max. 24 V switching voltage)

Tab. 24: Terminal assignment connection status relay

3.4.8 Connection external release

The operation of the system can be released or locked by an external release signal. The potential-free release contacts are on terminal X1 master controller and are bridged by the factory.

Terminal X1 master controller	Contact designation
X1.14	External release
X1.15	External release (GND)

Tab. 25: Terminal assignment connection external release

In case of removal of the bridge and no external release, the following visualisations are generated:

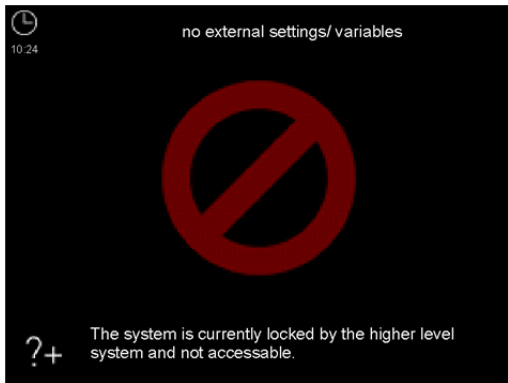
TFT touch panel	LED control panel
	L1 and L7 light up

Tab. 26: Visualization no external release

3.4.9 Connection digital inputs or outputs

The digital inputs or outputs DIO1 and DIO2 can only be programmed with the configuration software. The following parameterisations are set by the factory:

DIO1: Activate automatic mode (as digital input signal)

DIO2: Message in general (as digital output signal)

Terminal X1 master controller	Contact designation
X2.1	Digital input or output 1 (can be parameterized)
X2.2	Digital input or output 1 (GND)
X2.3	Digital input or output 2 (can be parameterized)
X2.4	Digital input or output 2 (GND)

Tab. 27: Terminal assignment DIO1 und DIO2

3.4.10 Operation without a control unit connected

When operating the ventilation device without control panel, the control operates according to the operating mode set last.



The control panel may only be disconnected from the BUS in de-energised condition. Disconnection during the operation results in a communication error!

3.5 Commissioning of the FOCUS

3.5.1 Operational readiness



Operational readiness is ensured if the requirements acc. to country-specific regulations are met. For that purpose, cleanliness of the air duct material, the availability, correct installation and operational readiness of the entire ventilation equipment provided for the plant must be particularly ensured.









Check all safety-relevant parts and perform a functional test!

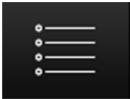

3.5.2 Adjusting the air volume flow

After having verified the operational readiness, the FOCUS can be commissioned as follows The ventilation device is configured according to plant design for the total intake air volume flow with nominal ventilation. This nominal air volume flow is parameterised in accordance with the characteristic curves of the chart 1 (with control unit TFT touch panel) in the setup / submenu Fan speeds or according to Tab. 29 (with control unit LED control panel).

3.5.2.1 Adjustment of the nominal air flow with TFT touch panel

For adjustment of the ventilation unit, the fan speed 2 (FS 2) for nominal air flow is set. The following settings have to be made using the TFT touch panel:

Symbol	Designation	Explanation / actions
	Button Menu mode	Connect the first TFT touch panel
	Buttons Navigation	By touching the button Menu mode, you reach the main menus.
	Button Password	By touching the navigation buttons, select the main menu setup and confirm with Enter.
	Buttons Navigation	By touching the navigation buttons, select the submenu Fan speeds and confirm with the Enter button.
	Button Fan speed 2 (FS2)	Activate the fan speed 2 (FS2) by touching the corresponding button.
	Buttons Navigation	Parameterise fan speed 2 (FS2) in accordance with characteristic curves for the nominal air volume flow

	Button Enter	Confirm by touching the Enter button.
	Button Cancel / back	By touching Cancel / back button, exit the menu levels until the start menu appears.

Tab. 28: Step sequence adjustment of the nominal air flow by means of the TFT touch panel



The values for balancing are factory-set and should only be modified if necessary.

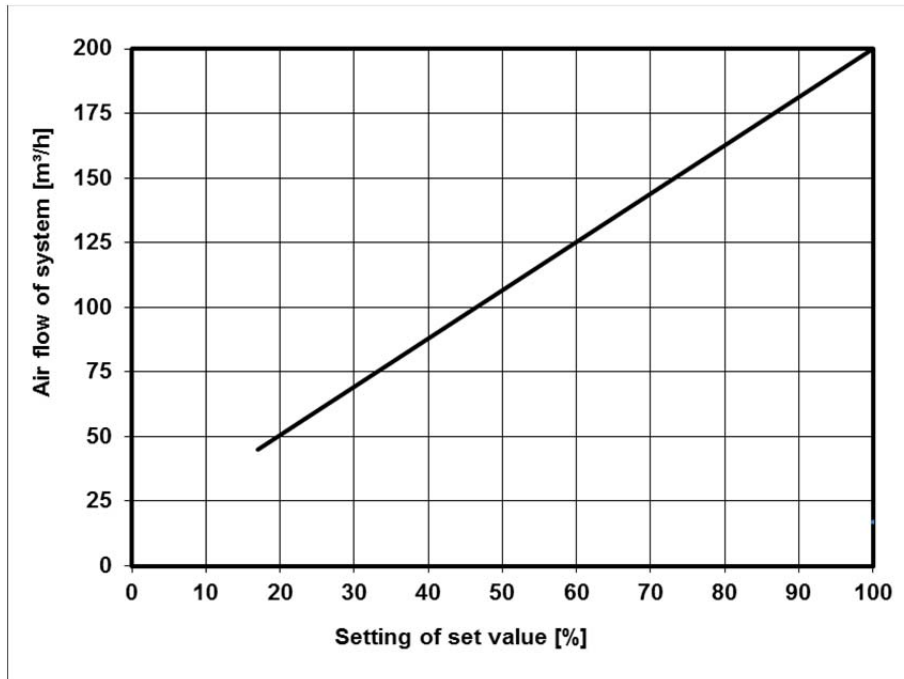

Fig 37: Chart 1, setting values nominal air flow FOCUS with fan speed 2 (FS2)

3.5.2.2 Adjustment of the nominal air flow with LED control panel

For adjusting the ventilation plant, the speed of the LED control panel which corresponds to the settings of set value. The seven steps of the LED control panel are factory-set values of the fans according to Tab. 29. Correspond to the adjusted level for the nominal air flow rate has the nearest set value from chart 1, Fig 37. During the adjustment of the valves, this fan speed is maintained.

Fan speed LED control panel	Setting of set value [%]
1	17
2	25
3	40
4	53
5	68
6	83
7	100

Tab. 29: Setting values nominal air flow

3.5.3 Adjustment of the Valves



Make sure that the supply and extract air valves are open as much as possible at the beginning of the volume flow measurement.

- Set the fans to nominal air volume flow.
- Adjustment of the air volume flows to the air valves by means of a volume flow hood and an anemometer (see air volume log)
- Adjustment of the air gap on the valve must not be too narrow – aerodynamic noises! Better: Adjustment of a lower fan output or restriction of the volume flow in the pipeline (installation of a throttle flap or throttle foam insert)
- Readjustment of the valves
- Locking of the adjusted positions of the valves and flaps
- Recording of the adjusted air quantity and all further adjustments in the designated documentations





3.6 Menu settings by qualified personnel / service staff

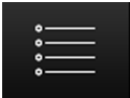

The password-protected parameters may only be changed by a competent expert or service staff!

3.6.1 Main menu Setup

The main menu **Setup** is divided in eight submenus. The access to the submenus is password-protected.

Symbol	Designation	Explanation / actions
	Button Menu mode	By touching the button Menu mode, you reach the main menus.
	Buttons Navigation	By touching the navigation buttons, select the main menu setup and confirm with Enter.
	Button Password	Password prompt Enter the password _ _ _ _ _ and confirm with Enter.
	Buttons Navigation	By touching the navigation buttons, select the respective submenu and confirm with Enter.

Tab. 30: Sequence of steps access main menu setup









The settings in the submenu are only applied if Enter is touched!!

3.6.1.1 Submenu Frost protection

The following settings are made in the submenu Frost protection:

- Parameterisation of the temperatures, () values factory setting:
 - Anti-freeze protection threshold intake air eco (-2.0 °C)
 - Anti-freeze protection threshold intake air safe (0.0 °C)
 - Anti-freeze protection threshold intake air moisture heat exchanger (-8.0 °C)
 - Anti-freeze protection threshold minimum supply air temperature (5.0 °C)
- Selection of the type of defroster heater
 - Electric defroster
 - PTC defroster
 - Brine defroster

Symbol	Designation	Explanation / actions
	Buttons Navigation	Temperatures Select by touching the navigation buttons (red background of the text) and confirm with Enter.
	Buttons Navigation	Anti-freeze protection thresholds Using the navigation buttons, the characteristic variables (red background of the text) to be parameterised can be selected and the values can be set using the buttons + / - .
	Buttons Enter Cancel / back	Confirm by touching the Enter button. By touching the Cancel / back button, exit the menu level.
	Buttons Navigation	Selection Type defroster heater Select the respective type by touching the navigation buttons (red background of the text).
	Button Checkmark	By touching the Checkmark button, the type of defroster heater is selected.
	Button Cancel / back	By touching the Cancel / back button, exit the menu levels until the start menu appears.

Tab. 31: Parameterization submenu frost protection





When falling below an anti-freeze protection threshold, an existing anti-freeze protection component is activated. If it remains falling below the anti-freeze protection threshold, this leads to switching off of the fans and an error message.

3.6.1.2 Submenu Fan speeds

In the submenu fan speeds, settings regarding the fan output and balancing can be made. for all three fan speeds. The supply air fans are parameterised separately for each fan speed in steps of 1% between 17 %...100 %. If necessary, balancing for each fan speed is performed by adjusting the exhaust air fan in the range -50 % ... +50 %. A varying fan output (imbalance) is calibrated by the service technician depending on the configuration of the system and is determined by means of the balance control.



Any change of the fan output via the main menu Settings can lead to a shift of the balance behaviour, in particular at the upper and lower limits of the fan characteristic curve.

Symbol	Designation	Explanation / actions
	Button Fan speed 1 (FS1)	Using the button Fan speed 1, activate the FS 1 and parameterise it with the navigation buttons. Setting range: 17 % < FS1 < FS2 Using the buttons + / -, an imbalance can be set.
	Button Fan speed 2 (FS2)	Using the button Fan speed 2, activate the FS 2 and parameterise it with the navigation buttons. Setting: FS2 = Nominal air volume flow Using the buttons + / -, an imbalance can be set.
	Button Fan speed 3 (FS3)	Using the button Fan speed 3, activate the FS 3 and parameterise it with the navigation buttons. Setting range: FS2 < FS3 < 100 % Using the buttons + / -, an imbalance can be set.



Buttons
Enter
Cancel / back

Confirm by touching the Enter button. By touching the Cancel / back button, exit the menu level.

Tab. 32: Parameterization submenu fan speeds

3.6.1.3 Submenu Post-heating

The following settings are made in the submenu post-heating:

- Parameterisation of the duct temperature
- Selection of the type of supplementary heater battery
 - Electric heater battery
 - Water supply heater

Symbol	Designation	Explanation / actions
	Buttons Navigation	Duct temperature Select by touching the navigation buttons (red background of the text) and confirm with Enter.
	Buttons + / -	Using the buttons + / -, set the duct temperature.
	Buttons Enter Cancel / back	Confirm by touching the Enter button. By touching the Cancel / back button, exit the menu level.
	Buttons Navigation	Selection Type supplementary heater battery Select the respective type by touching the navigation buttons (red background of the text).
	Button Checkmark	By touching the Checkmark button, the type of supplementary heater battery is selected.
	Button Cancel / back	By touching the Cancel / back button, exit the menu levels until the start menu appears.

Tab. 33: Parameterization submenu post-heating

3.6.1.4 Submenu Summer ventilation without by-pass

This menu shows whether summer ventilation without by-pass is possible. The menu can only be executed, if there is no by-pass.

The following settings are made, () values factory settings

- Temperature for activating the function (25.0 °C)
- Hysteresis (0.5 °K)
- Inactive below (13.0 °C)

Symbol	Designation	Explanation / actions
	Button Checkmark	The symbol shows the feasibility of the menu.
	Buttons Navigation	Temperature / Hysteresis/ inactive below Select by touching the navigation buttons (red background of the text) and confirm with Enter.
	Buttons + / -	Set the selected parameter with the buttons + / - .



Buttons
Enter
Cancel / back

Confirm by touching the Enter button. By touching the Cancel / back button, exit the menu level.

Tab. 34: Parameterization setting submenu summer ventilation without by-pass



The following switch conditions are provided for the summer ventilation without bypass (as an example related to device version LEFT):

Parameter	Parameter description
T1:	Temperature of intake air (x_int) at temperature sensor T1 of the device
T3:	Temperature of extract air (x_ext) at temperature sensor T3 of the device
t_sum:	Temperature threshold for activating the summer ventilation
t_int_min:	Limit for intake air temperature
H_sum:	Hysteresis of the temperature threshold for activating the summer ventilation
Function	Switching conditions
ACTIVE,	if: $T1 < T3 \ \& \ T1 > t_int_min \ \& \ T3 > t_sum + H_sum$

Tab. 35: Switching conditions for function of the summer ventilation

3.6.1.5 Submenu Ground pipe diverter valve



In this menu, it is specified whether a flap of the geothermal heat exchanger is available.

Symbol	Designation	Explanation / actions
 	Button Checkmark	By touching the button Checkmark, an available flap of the geothermal heat exchanger is released.
	Button Cancel / back	By touching the Cancel / back button, exit the menu levels until the start menu appears.

Tab. 36: Parameterization flap of the geothermal heat exchanger

3.6.1.6 Submenu Reset factory data

In the submenu Reset factory data, the device can be reset to factory data.

Symbol	Designation	Explanation / actions
 	Button Checkmark	By touching the button Checkmark, the plant is reset to factory data.
	Button Cancel / back	By touching the Cancel / back button, exit the menu levels until the start menu appears.

Tab. 37: Reset factory data

3.7 Maintenance and repair by qualified personnel



If regular maintenance work is not performed at the FOCUS, this impairs the functioning of the comfort ventilation.

The maintenance and repair by qualified personnel should only be carried out by a maintenance service on the basis of a maintenance contract. The maintenance and repair measures for the FOCUS include the inspection and cleaning of the fans and the heat exchanger. Cleaning of the heat exchanger is carried out depending on the degree of soiling; the maintenance interval should not exceed two years.



The maintenance work performed must be documented in check list B!

3.7.1 Inspecting and cleaning the heat exchanger

In order to do so, proceed as follows:

1. Disconnect the FOCUS from the power supply.
2. Press both spring locks **A** on the bottom side and unlock with it the front plate.

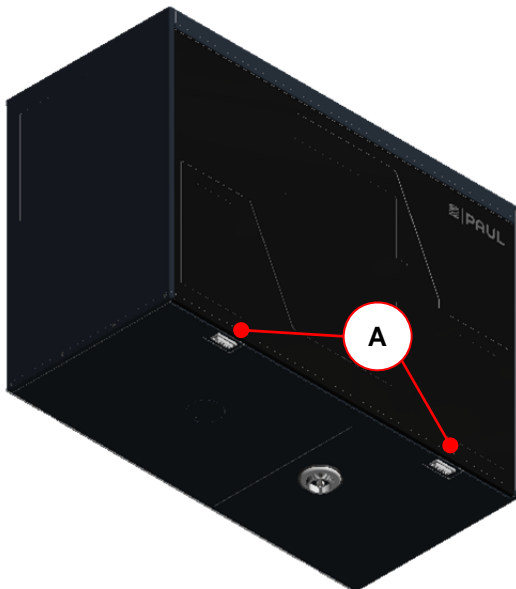

Fig 38: Press of the spring locks

3. Remove the front plate **B** according the step sequence 1. and 2. and gradually to the directions of the arrows. Open the front plate in a corner from maximally 15 ° and hang them from the tin fold of the housing.

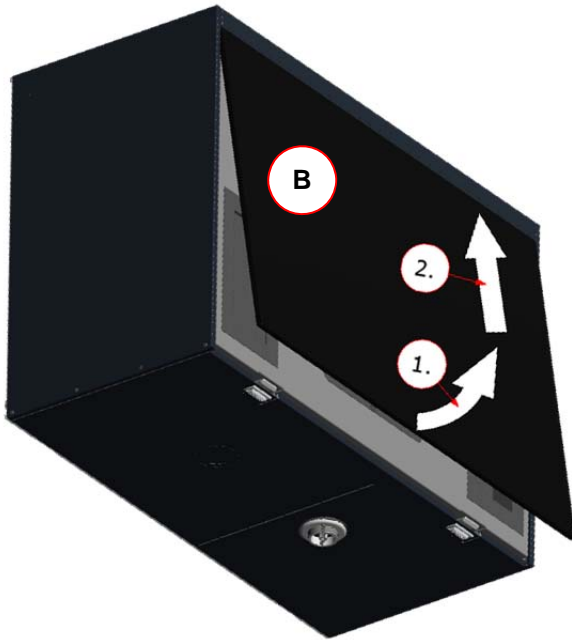

Fig 39: Opening the front plate

4. Pull by means of strap **C** the EPP foam cover of the filters and the heat exchanger **D** from the foam housing. Thereby, take and pull the strap at one of the ends and counter-hold the device with the other hand at the same time.

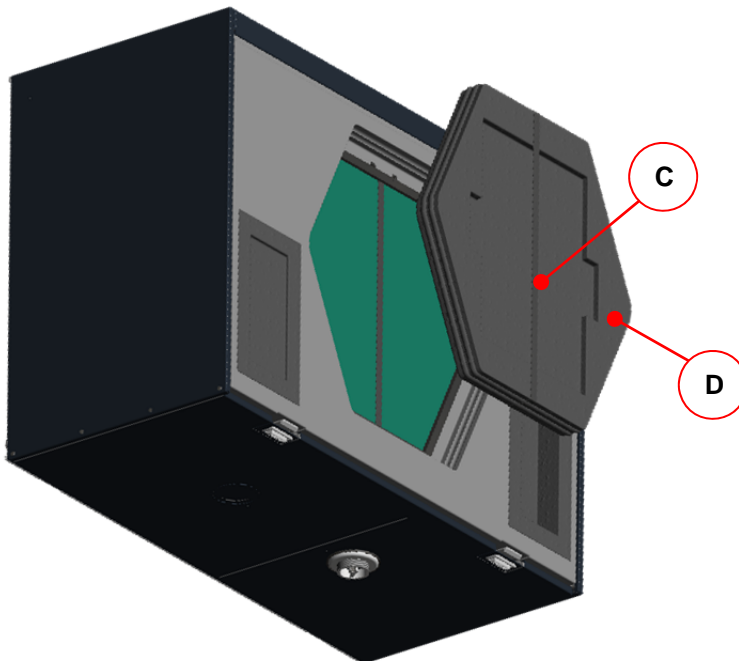

Fig 40: Dismantlement of the EPP foam cover

5. Remove the filters on the strap **E** from the filter holder.

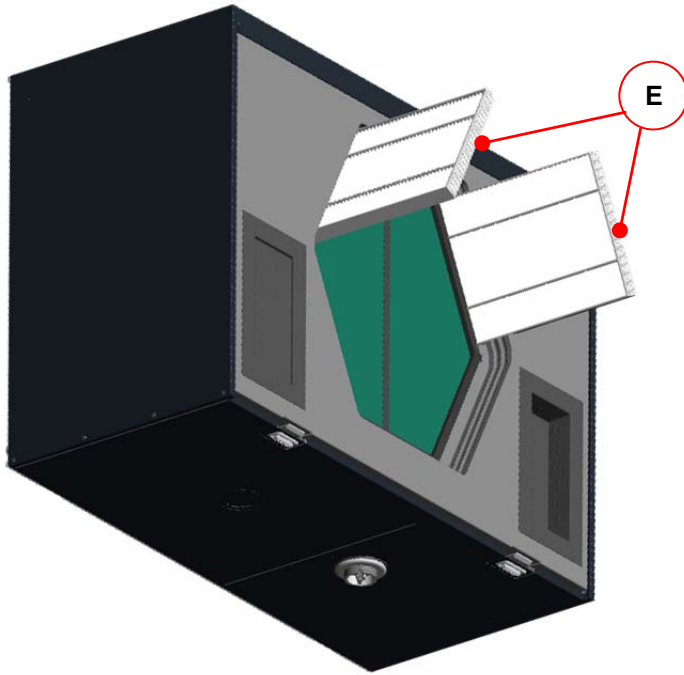

Fig 41: Remove the filters

6. Now pull the heat exchanger **G** by means of the strap **F** from the EPP housing.

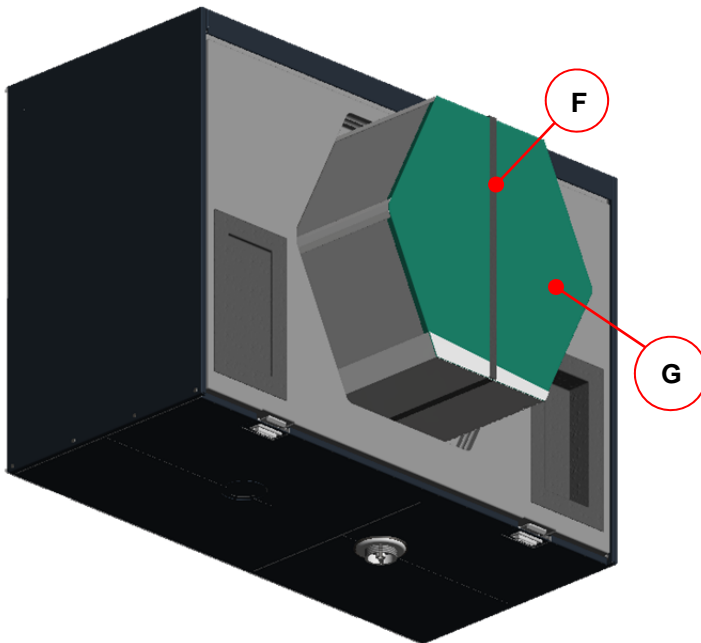

Fig 42: Remove the heat exchanger

7. Clean the heat exchanger as following:
 - Dip the heat exchanger into warm water several times (max. 40 °C).
 - Subsequently, thoroughly rinse the heat exchanger using warm tap water (max. 40°C).



As a general rule, do not use any aggressive or dissolvent detergents!

- For drying, position the heat exchanger in such a way that existing residual water can run out of the openings.
- Let the heat exchanger run completely dry before reinstalling it.



Hints for proper cleaning can also be found at the manufacturer's website.

8. Installation of the heat exchanger



Please note when installing the heat exchanger!

On the bottom of the heat exchanger is a condensate pan **H** with two cut-outs. When inserting the heat exchanger into the unit, please assure that the two cut-outs of the condensate pan point to the condensate outlet **I** !

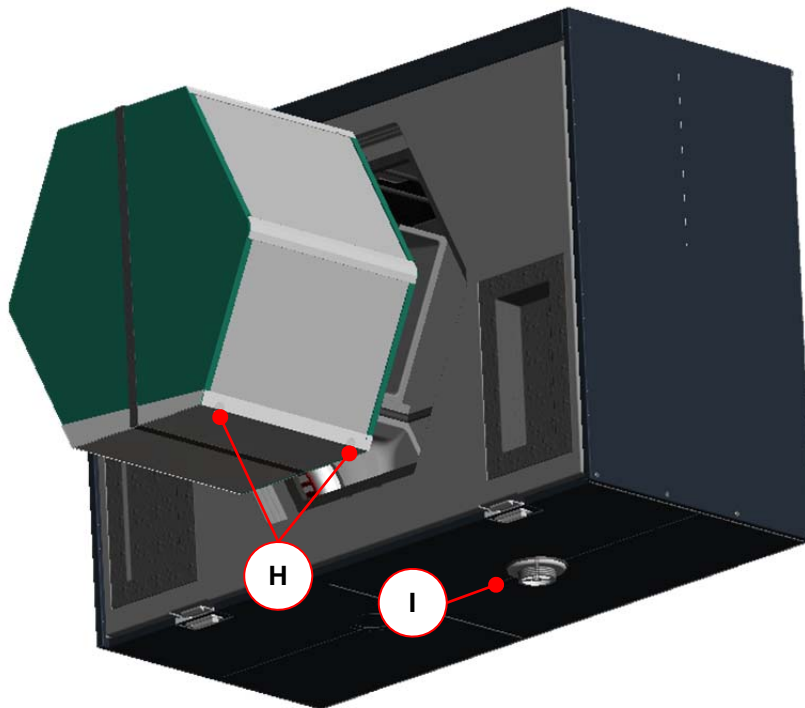

Fig 43: Position of the condensate pan when inserting the heat exchanger into the HRU

9. Afterwards, mount all parts in reverse order.
10. Re-establish the mains connection.

3.7.2 Replacement of the heat exchanger type

The FOCUS can be equipped and operated with two different heat exchanger types:

- Cross-counter flow channel heat exchanger made of plastic (standard heat exchanger)
 - Cross-counter flow enthalpy exchanger (membrane moisture heat exchanger)
1. Perform the work steps 1. to 6. pursuant to 3.7.1.
 2. Insert the respective heat exchanger type considering the notes on Fig 43, and perform the work steps 9. to 10. pursuant to 3.7.1.
 3. Parameterise the frost protection mode pursuant to 2.3.2.3 in the menu Settings / submenu Frost protection for the respective heat exchanger type.



Only the frost protection modes eco and safe may be set for a standard heat exchanger!

3.8 Visualisation of errors and error treatment

The device control is equipped with an internal system for error detection.. The visualisation of the error messages and the error forecast is made according to the display possibilities of the connected control panel.

In response to an error condition, the fans are switched off.

3.8.1 Error signalling by means of the LED control panel

The visualisation of errors with the LED-control panel is carried out on the basis of 2.2.1.2. In addition to the signalling of the error conditions, an LED coding, which does binary present the meaning of the error, is generated by means of the LEDs L1...L7. Information on checking / measures for a possible elimination of the error condition are given in Tab. 39.

The following LED-combinations for the display of the error coding marked with "x" apply:

LED combinations							Error message	Possible cause
L1	L2	L3	L4	L5	L6	L7		
x		x					Supply air temperature too low	Supply air temperature < setpoint
x	x		x	x		x	BUS version incompatible	Software versions of the components not compatible
		x	x	x		x	Too many devices connected	Too many components connected to the BUS
x		x	x	x		x	Fan slave not connected	Lack of BUS-communication
	x	x	x	x		x	Communication error of the fan slave	Lack of BUS-communication
x	x	x	x	x		x	Communication error of the defroster	Lack of BUS-communication
					x	x	Communication error of the heater battery	Lack of BUS-communication
x					x	x	Comm. error flap of the geothermal heat exchanger	Lack of BUS-communication
	x				x	x	Comm. error general	Lack of BUS-communication
x	x				x	x	Heating does not switch off	Error BUS-thermostat
	x		x	x			General control unit error	Lack of BUS-communication with control unit

Tab. 38: Overview binary error coding with LED control panel

3.8.2 Visualisation of errors with the TFT touch panel

The visualisation of errors with the TFT touch panel is done in the plain text display of the error message. In the main menu Information / Last message, the last three errors that occurred are registered in compliance with the event with date and time. In addition to this display, a yellow warning triangle flashes in the upper right edge of the screen.

The following plain text displays of the error message are visualised:

Message on display	Possible cause	Control / Action
Error sensor 1	Sensor break or short circuit temperature sensor Version LEFT T1 Version RIGHT T3	Check or replace sensor
Error sensor 2	Sensor break or short circuit temperature sensor Version LEFT T2 Version RIGHT T4	Check or replace sensor
Error sensor 3	Sensor break or short circuit temperature sensor Version LEFT T3 Version RIGHT T1	Check or replace sensor
Error sensor 4	Sensor break or short circuit temperature sensor Version LEFT T4 Version RIGHT T2	Check or replace sensor
Supply air temperature too low	Minimum supply air temperature < setpoint;	Supply air temperature > setpoint + 1 K
Intake air temperature too low	Current intake air temperature < setpoint; longer than 30 minutes	Intake air temp > setpoint; control after 1 h
Error fan 1 Hall	Version LEFT; supply fan speed does not report Version RIGHT, exhaust fan speed does not report	manual adjustment of fan speed
Error fan 2 Hall	Version LEFT; exhaust fan speed does not report Version RIGHT, supply fan speed does not report	manual adjustment of fan speed
BUS version incompatible	Software versions of the components not compatible	Replace software versions
Too many devices connected	Too many components connected to the BUS	Remove surplus components
Fan slave not connected	Lack of BUS-communication	Fan slave connected
Communication error fan slave	Lack of BUS-communication	Check BUS-communication
Comm. error defroster	Lack of BUS-communication	Check BUS-communication
Comm. error heater battery	Lack of BUS-communication	Check BUS-communication
Comm. error flap of the geothermal heat exchanger	Lack of BUS-communication	Check BUS-communication
Comm. error general	Lack of BUS-communication	Disconnection from power supply, then restart
Heating does not switch off	Error BUS-Thermostat	Replace BUS-Thermostat

Tab. 39: Overview visualisation of errors and error treatment with TFT touch panel

3.9 Technical description

3.9.1 Types of device

FOCUS 200 - series

Ventilation unit with counter flow channel heat exchanger of plastic

FOCUS F 200 - series

Ventilation unit with counter flow enthalpy exchanger with polymer membrane

3.9.2 Designs layout air connection

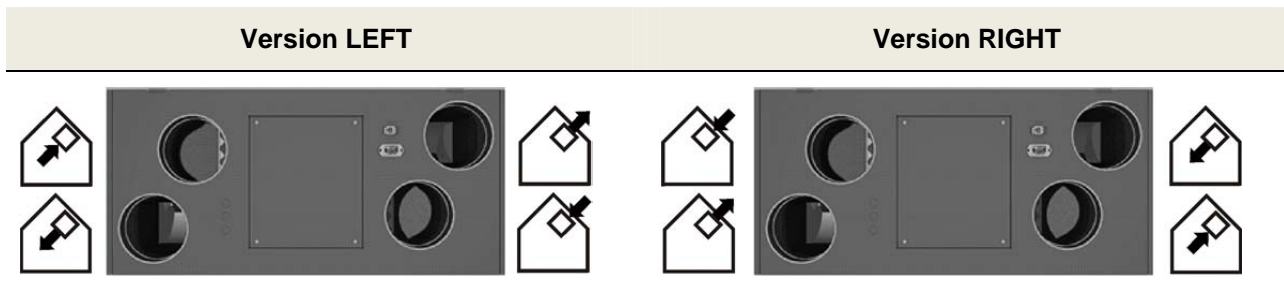

Tab. 40: Overview types of designs layout air connection

3.9.3 Technical specification

General specification	Description / value
Type of heat exchanger	Counter flow channel heat exchanger of plastic (FOCUS 200 - series) Counter flow enthalpy exchanger with polymer membrane (FOCUS F 200 - series)
Casing / internal lining	Steel sheet galvanised, powder-coated, thermal bridge-free; internal lining made of expanded polypropylene EPP for thermal and sound insulation
Pipe connections	DN 125 (sleeve dimension)
Weight	25 kg
Electrical connection	230 Vac, 50-60 Hz; 2 m power cable with plug connection of a low power device
Connected load	140 W
Protection class	I
Degree of protection	IP 40
Limitations of use	-20 to 40 °C
Assembly site	Frost-free interior area; Ambient conditions: < 70 % r. F. at 22 °C
Installation position	Horizontally wall mounting or on mounting frame (Option)

Tab. 41: Generell specification

Operating data	Value
Air flow	45 to 200 m ³ /h
Efficiency criterion	0,31 Wh/m ³ (at 135 m ³ /h / 100 Pa)
Heat recovery rate acc. PHI	91 % (at 135 m ³ /h / 100 Pa); FOCUS 200
Sound, device emission (acc. to DIN EN ISO 3743-1, distance of 3 m)	30 dB(A) (at 155 m ³ /h / 100 Pa) 24 dB(A) (at 200 m ³ /h / 100 Pa)

Tab. 42: Operating data

Certificates / Approvals	FOCUS 200
	Passivhouse-certificate
	Certificate acc. NBN EN 308
	Approval of the DIBt AbZ Z-51.3-272

Tab. 43: Certificates / Approvals

p- \dot{V} -characteristic curve

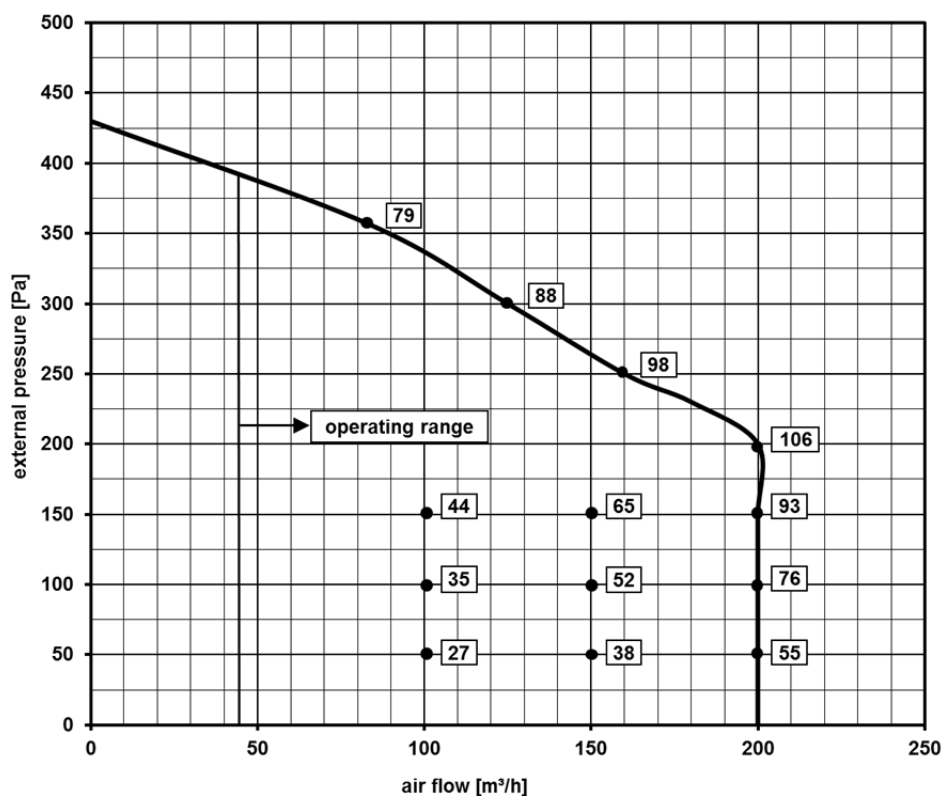

Please note:

The numerical values of the p- \dot{V} -characteristic curve which are illustrated in the chart indicate the power consumption in [W] in the respective operating points.

Tab. 44: Chart 2, p- \dot{V} characteristic curve FOCUS 200

3.9.4 Dimensional sketch

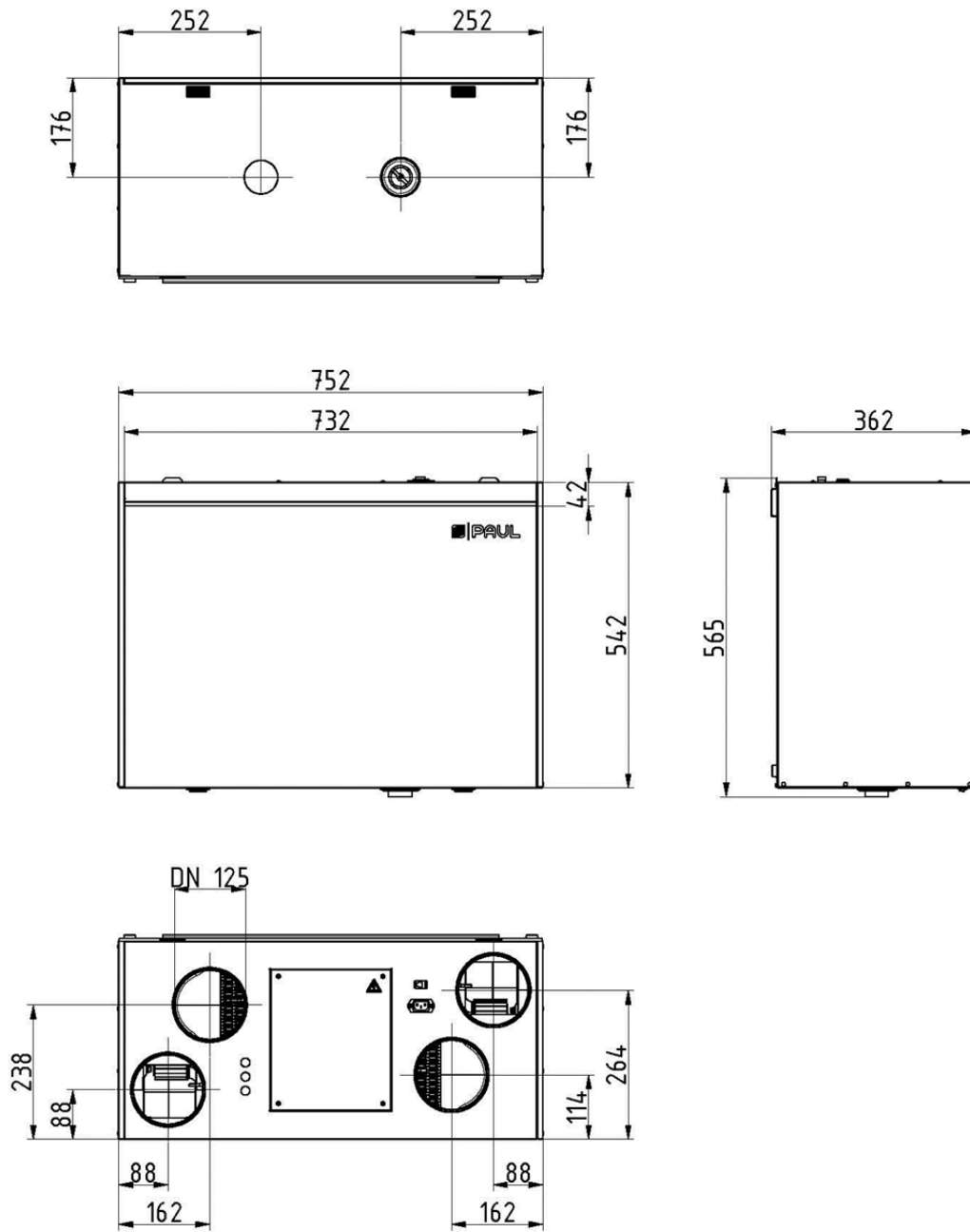
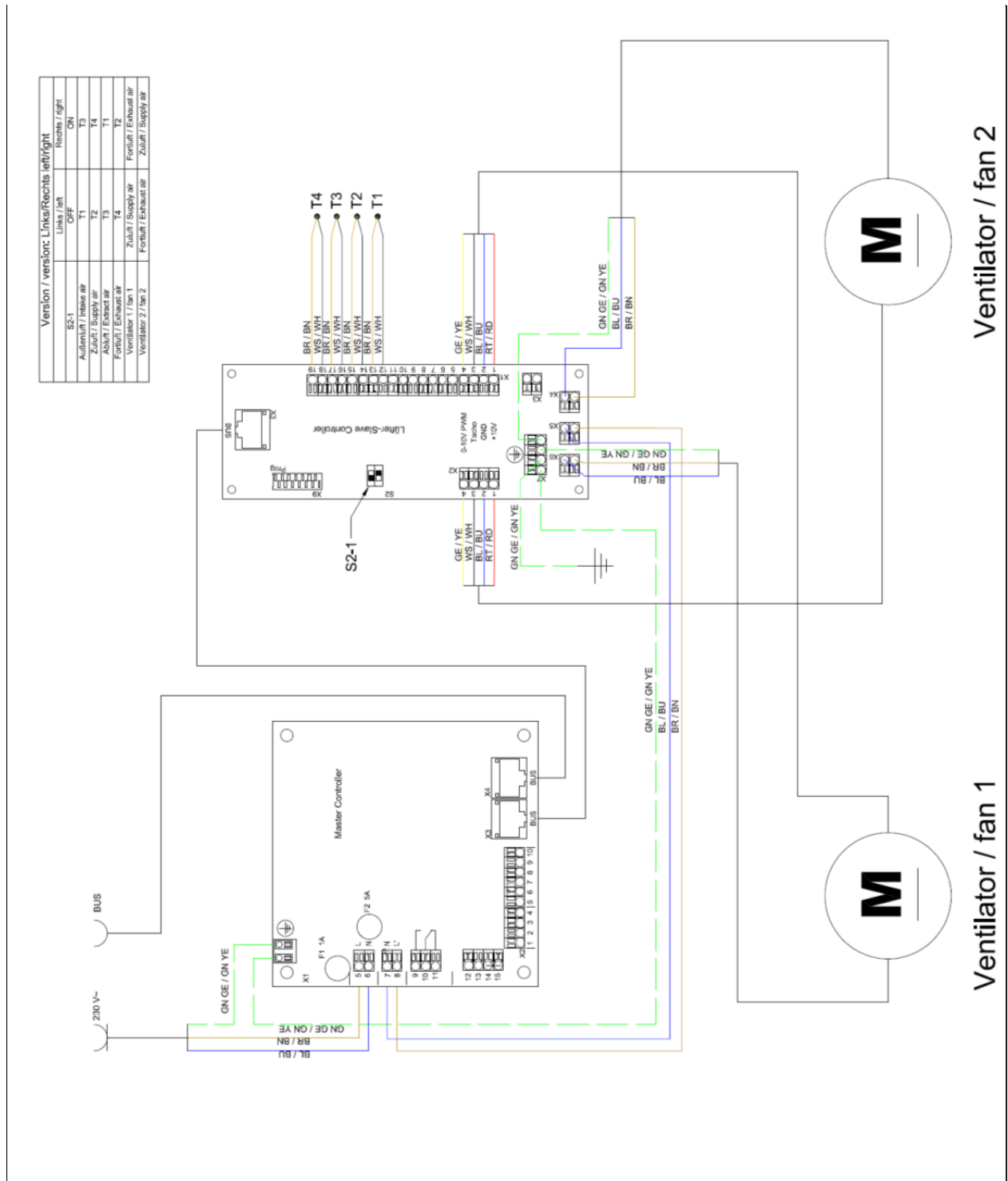

Fig 44: Dimension drawing FOCUS (F) 200

3.9.5 Plant 1 circuit diagram FOCUS (F) 200



Version / version:	Links/Rechts	left/right
S2-1	Links / left	Rechts / right
	ON	ON
Außenluft / Intake air	T1	T3
Zuluft / Supply air	T2	T4
Abluft / Exhaust air	T3	T1
Fortluft / Exhaust air	T4	T2
Ventilator 1 / fan 1	Zuluft / Supply air	Fortluft / Exhaust air
Ventilator 2 / fan 2	Fortluft / Exhaust air	Zuluft / Supply air

3.9.6 Plant 2 terminal scheme master controller

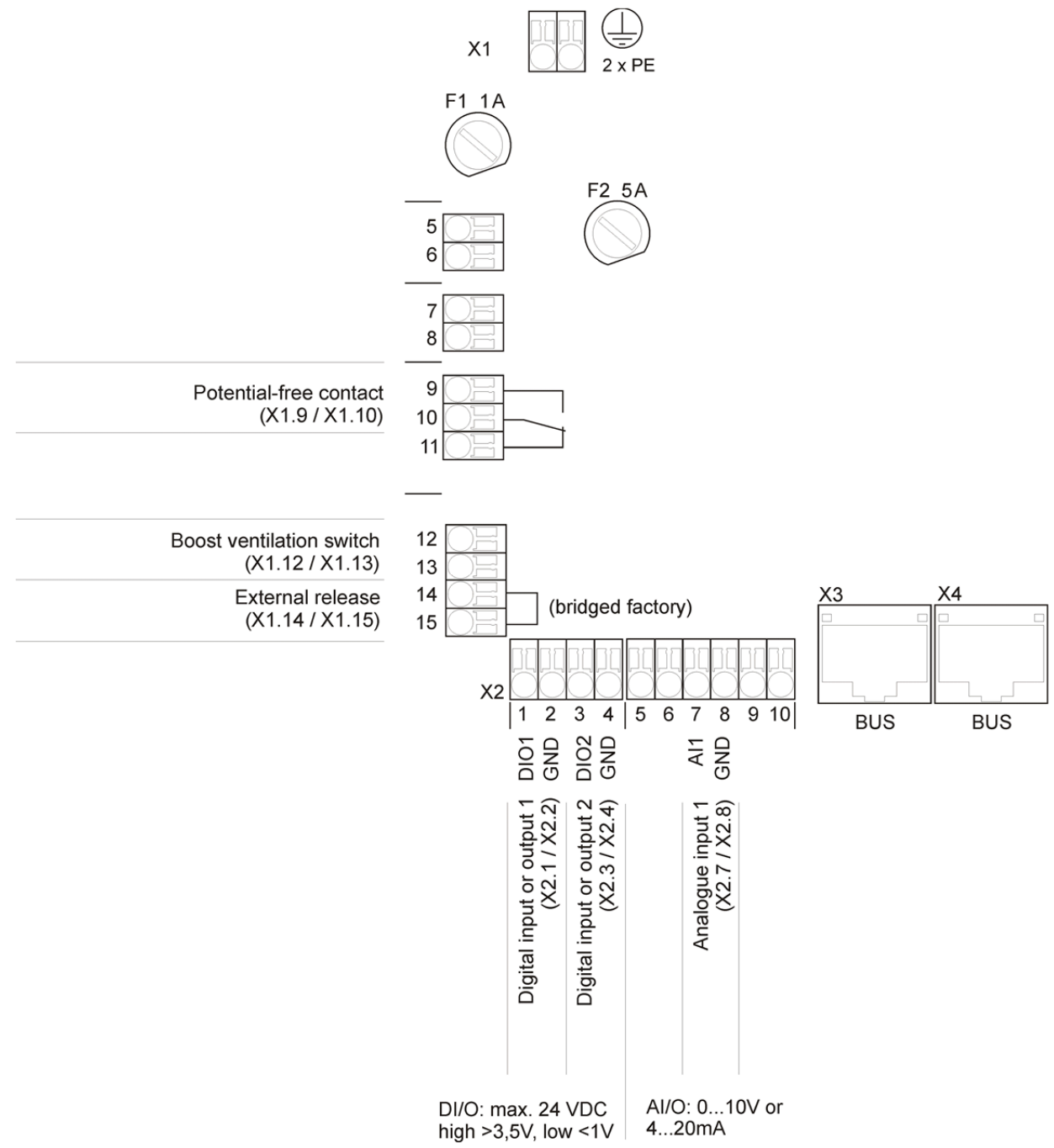

Date: 03/02/14
 Subject to change
 in the interest of technical
 progress.

Checklist A Maintenance by customer



Maintenance Work Enter date in the quarter

1. Change both filters in the MVHR unit (change every 90 days)

Quarter Year	I	II	III	IV
201...				
201...				
201...				
201...				
201...				
201...				
202...				
202...				
202...				
202...				

2. Clean extract air prefilter / filter in extract air valves (change approx. every 2 months)

Quarter Year	I	II	III	IV
201...				
201...				
201...				
201...				
201...				
201...				
202...				
202...				
202...				
202...				

3. Change other filters in the system (outdoor air intake - also at ground heat exchanger) – all 6-12 months)

Quarter Year	I	II	III	IV
201...				
201...				
201...				
201...				
201...				
201...				
202...				
202...				
202...				
202...				

Date: 03/11/14

Subject to change
in the interest of technical
progress.

Checklist B Maintenance by skilled personnel



Maintenance Enter result

- Inspection of MVHR unit based according to the currently valid national standards
- Informal report for comments on MVHR unit's condition
- Use additional sheet of paper for adding reports of subsequent years

No.	Components	Action / Interval	Result	201...	201...	201...	201...	201...
1	Fan / MVHR unit	Components cleaned? - fans - Heat exchanger - air-contacting surfaces of the device - preheater - condensate pan, siphon,	yes / no					
		Frost protection device functional?	yes / no					
		Structure-borne-noise transmission, fixings are avoided?	yes / no					
		Preheater / vaporizer / heat exchanger are not contaminated?	yes / no					
2	Condensate drain and siphon	Status indicators are working?	yes / no					
		Working?	yes / no					
3	Electronic controls	Condensate disposal OK?	yes / no					
		Cable connections and clamp fixing secure?	yes / no					
4	Air ducts / heat insulation	Control units working?	yes / no					
		Cleaning done (if required)? Test OK?	yes / no					
		Heat insulation and vapor barrier diffusion-close OK?	yes / no					
5	Ground to air heat exchanger (if available)	Flexible connections between MVHR and air ducts OK?	yes / no					
		Changeover working?	yes / no					
		Outdoor air intake free?	yes / no					
		Condition of prefilter OK?	yes / no					
6	Fan / MVHR unit and fireplace operating mode (if available)	Condensate drain OK?	yes / no					
		Cleaning of the GHE (rinsing)	yes / no					
7	Fan / MVHR unit / other filters, filter condition	Safety device with firing installation working?	yes / no					
8	Extract air / supply air outlet Overflow air ducts	Filters of correct filter class installed?	yes / no					
		Fit and lock OK?	yes / no					
		Filter condition OK?	yes / no					
		Air flow according air flow report OK?	yes / no					
9	Overflow air ducts	Free cross-section?	yes / no					
		No structure-borne / airborne noise transmission?	yes / no					
		Safety device with firing installation working?	yes / no					

Date: 03/02/14 Subject to change in the interest of technical progress.	<h2 style="margin: 0;">Air Flow Report</h2> <h3 style="margin: 0;">Operating condition, functional check¹⁾, instruction</h3>	
---	---	--

Customer data		
Surname:	Surname:	Surname:
Street:	Street:	Street:
Construction project:		

MVHR-type:	MVHR-type:	MVHR-type:
------------	------------	------------

Measured data		
Measuring equipment used:	Fault descriptions during measurement:	Indoor temperature ²⁾
		Outdoor temperature ²⁾
		Weather ²⁾

Filter condition on calibration	Supply	Extract	Building moisture condition:	Fan speed ratio
clean		 % RH without	Extract air / Supply air
used for approx. ... days			ventilation mode
very dirty				

Supply air				Ventilation step:	%
No.	Room description	No.		Room description	

Extract air				Ventilation step:	%
No.	Room description	No.		Room description	

Pel = W (2 fans)

¹⁾ The volumetric air flow is measured during normal MVHR operation ³⁾ as agreed.
²⁾ acc. to DIN EN 14134, Item 7.3.1.5.
³⁾ acc. to DIN EN 14134, Item 7.4.1. b) end
⁴⁾ acc. to DIN 1946-6 MVHR unit has to run continuously, except for times of maintenance or repair. Use lowest ventilation step or intermittent unoccupied program in times of absence.

- ⇒ The user has been instructed on the hygienic requirements ⁴⁾ for the operation of the MVHR unit
- ⇒ Customer has been advised that winter and summer operation influence the interior air humidity. If too dry air (<30% RH → in winter) can create a moist heat exchanger transferring remedy - this can be supplied in many PAUL devices.
- ⇒ No parts other than genuine PAUL parts (e.g. filters) shall be used, otherwise the warranty will be void
- ⇒ The warranty period starts with delivery ex works

Date: Signatures:

Startup personnel / Plumber User

Date: 03/02/14 Subject to change in the interest of technical progress.	Commissioning and handover certificate Completeness and performance verifications acc. to DIN 1946-6	
---	---	---

Customer data		
Surname:	Surname:	Surname:
Street:	Street:	Street:
Construction project:		
MVHR-type:	MVHR-type:	MVHR-type:

Completeness			
No.	Device	Ausführung	Result
1	Supply air duct	- Version as planned - Cleaning possible	yes / no yes / no
2	Supply air outlets	- Configuration as planned - Version as planned - Cleaning possible - sufficient distance from the wall	yes / no yes / no yes / no yes / no
3	Overflow air outlets	- Configuration as planned - Version as planned	yes / no yes / no
4	Extract air outlets	- Configuration as planned - Version as planned - Cleaning possible - Pre-filter provided as planned?	yes / no yes / no yes / no yes / no
5	Extract air duct	- Cleaning possible	yes / no
6	Extract air fan	- Cleaning possible	yes / no
7	Control unit	- working?	yes / no
8	Filters, optional	- Possibility to change - or clean	yes / no
9	Heat exchanger for heat recovery	- Cleaning possible	yes / no
10	Extract air heat pump, optional	- Cleaning possible	yes / no
11	Condensate drain, optional	- working?	yes / no
12	Ground to air heat exchanger, optional	- Cleaning possible	yes / no
13	Duct heater, optional	- Cleaning possible	yes / no
14	Solar panel	- Cleaning possible	yes / no
15	Documentation / manual	- available	yes / no

Function			
1	Ready to use in standard mode (nominal ventilation), as planned	Result OK further steps necessary	yes / no yes / no
2	Different modes possible, as planned	Result OK further steps necessary	yes / no yes / no
3	Power consumption	Result OK further steps necessary	yes / no yes / no

Confirmation	
<p>Date: Signature/Stamp:.....</p> <p style="text-align: right;">Startup personnel / Plumber</p>	

PAUL Wärmerückgewinnung GmbH
August-Horch-Straße 7
08141 Reinsdorf
Germany
Tel.: +49(0)375 - 303505 - 0
Fax: +49(0)375 - 303505 - 55



EC-DECLARATION OF COMPLIANCE

Herewith we declare that the product/ product series designated below complies with the relevant, essential health and safety requirements of the applicable EC directives mentioned below on the basis of its design, type of construction and in the version marketed by us.

Product description: Mechanical ventilation heat recovery (MVHR) unit FOCUS 200 – series
FOCUS F 200 – series

Directive 2004/108/EC of the European Parliament and of the Council of 15 December 2004 on the approximation of the laws of the Member States relating to electromagnetic compatibility and repealing Directive 89/336/EEC

Applied standards:

EN 61000-6-1 Electromagnetic compatibility (EMC) - Part 6-1: Generic standards - Immunity for residential, commercial and light-industrial environments

EN 61000-6-3 Electromagnetic compatibility (EMC) - Part 6-3: Generic standards - Emission standard for residential, commercial and light-industrial environments

EN 55011 Industrial, scientific and medical equipment - Radio-frequency disturbance characteristics - Limits and methods of measurement

Directive 2006/42/EC of the European Parliament and of the Council of 17 May 2006 on machinery, and amending Directive 95/16/EC (recast)

Applied standards:

EN ISO 12100-1 Safety of machinery – risk assessment and risk reduction

EN ISO 3744 Acoustics - Determination of sound power levels and sound energy levels of noise sources using sound pressure - Engineering methods for an essentially free field over a reflecting plane

EN ISO 5136 Acoustics - Determination of sound power radiated into a duct by fans and other air-moving devices - In-duct method

Directive 2006/42/EC of the European Parliament and of the Council of 12 December 2006 on the harmonization of the laws of Member States relating to electrical equipment designed for use within certain voltage limits

Applied standards:

EN 60335-1; EN 60335-2-40+A2 Safety of electric appliances for domestic and similar uses – general requirements / special requirements for electric heat pumps, air conditioning units and indoor air humidifiers

Reinsdorf, 15th of January 2015
Paul Wärmerückgewinnung GmbH

A handwritten signature in black ink, appearing to read "Michael Pitsch".

Michael Pitsch
CEO



PAUL Wärmerückgewinnung GmbH
August-Horch-Str. 7
08141 Reinsdorf
Germany

Tel: +49 (0) 375 - 30 35 05 0
Fax: +49 (0) 375 - 30 35 05 55

info@paul-lueftung.de
www.paul-lueftung.de